



alfa 

Workshop furniture

	Drawer cabinets PROFI				Drawer cabinets UNI	Workshop trolleys	Workbenches		Workshop cabinets		Perfo systems	Holders for tools	Plastic bins	Computer cabinets	Fire extinguishers	Surface treatment
dimensional line	2727E	3627E	4527E	5427E			ALCERA	ALPEDE	system	universal	mobile					
	3636E	4536E	5436E		ALSOR	ALNAK	warehouse		stationary							

Alfa3, s.r.o. is an innovative, towards customers oriented production company which has been dealing with development and production of steel furniture for more than 20 years. Due to the longtime experience and the involvement of our employees we are able to supply not only quality products, but also to ensure a professional consultancy and service.

Our products are characterized by a quality processing, modern design, massive welded construction and tough surface treatment. During the product's construction process we care about using maximally the well-approved unit-principle items and the constructional complexes which make a guarantee of a high level reliability also of the new or customized products.

We use the first class materials only and well-approved components bought from the prestigious suppliers. The production itself is realized mostly by using the high precise CNC machines. The surface treatment is realized through the IDEAL-LINE coating line equipped with the GEMA MagicCylinder II coating box with CM30 operation system and 12 automatic electrostatic coating guns.

We are still looking for any occasions to higher the efficiency and productivity of our processes. We use the modern environment-friendly technologies. The quality management system is certified by ČSN EN ISO 9001:2009. We are authorized to use the Czech product mark.

The workshop furniture presented in this catalogue we produce in two basic product lines:

- **The PROFI line** is designed for higher weighting of shelves and ejecting systems. There is a wide assortment of **standard products**. Our customers can possibly use the section **Individual programme, accessories** and configure an own product furnished according to the needs of a particular workplace.
- **The UNI line** is designed for lower weighting of shelves and drawers. In the catalogue you can find a wide assortment of **standard products** which are intended especially for light industry plants or assembly workplaces. The accessory assortment is in comparison to the PROFI line limited.

The outer look of our PROFI and UNI line products consists of unifying design items which give a possibility to our customers to furnish their plants in one design.

Catalogue contents

Drawer cabinets PROFI

The drawer cabinets of the PROFI line represent a suitable solution for demanding industry applications. We offer a big number of drawer cabinets in different dimensions and also a wide assortment of additional items of equipment and accessories. It ensures that you will find an optimal solution fitted to each plant.

Workshop drawer cabinets UNI

Workshop trolleys DVU

Workbenches

This section contents an overview of particular items of workbenches and some examples of already configured sets of workbenches with cabinets of the PROFI and UNI lines. The sets are well-exposed and all the items used are described in details. This can be used as a sample for your own configuration concept.

Vertical tool cabinets

Workshop cupboards

The workshop cupboards with wing doors are popular due to their ratio between their price and deposit volume. They represent a good choice for storing materials, tools, equipment and documents in industry plants. In this section you will find four basic model lines of cupboards. A wide assortment of products' standard versions together with an option to design an individual cupboard's set made of the PROFI line components ensure an easy choice of the right cupboard's version for a particular application.

EUROPERFO® and ALFABOX® systems

Drawer divider sets, holders for tools

Plastic bins

Computer cabinets

The computer cabinets protect computers which are placed directly at production plants. You can choose versions which can be furnished with a distribution switchgear with a ventilator or with holders intended for 19" rack components installation.

Cabinets for fire extinguishers and first aid kits

Surface treatment and safety instructions

page

4 - 37

38 - 39

40 - 41

42 - 61

62 - 63

64 - 81

82 - 85

86 - 87

88 - 93

94 - 95

96 - 97

98 - 99



10000



List of equipment of the PROFI and UNI lines cabinets and cupboards

The drawer and shelf cabinets we produce in two basic product lines:

Line **PROFI** is designed for higher weighting of shelves and drawers, its standard version is better equipped and the customer has a big choice from a wide assortment of already configured versions of cabinets or they can create their own configuration of the product within the individual programme.

Line **UNI** is designed for lower weighting, it is equipped in more simply way and the customer can choose from a wide assortment of already configured cabinets.

In the following table we introduce the basic differences in equipment of the PROFI and UNI cabinets:

Drawer cabinets	PROFI	UNI
Code	DKP	DKU, DVU
Drawer carrying capacity - sliding	90 kg - 80% 65 kg - 100% 180 kg - 100%	40 kg - 100%

Central locking of drawers	■	■
Protection against opening of several drawers together	■	■
Safety pin against drawers' opening - mobile versions	■	■
Preparation for metal divider sets installation in longitudinal and transverse direction	■	■
Perforation of the bottom part of the drawer intended for fitting of the metal divider sets	■	■
Preparation for metal divider sets installation in transverse direction only	■	■
Option to install a drawer damping	■	■

■ standard equipment ■ extra charge equipment ■ not available

Shelf cabinets	PROFI	UNI
Code	DSP	DSU
Drawer carrying capacity - sliding	90 kg - 80% 65 kg - 100% 180 kg - 100%	40 kg - 100%

Central locking of drawers	■	■
Protection against opening of several drawers together	■	■
Preparation for metal divider sets installation in longitudinal and transverse direction	■	■
Perforation of the bottom part of the drawer intended for fitting of the metal divider sets	■	■
Preparation for metal divider sets installation in transverse direction only	■	■
Option to install a drawer damping	■	■

■ standard equipment ■ extra charge equipment ■ not available

Drawer cabinets PROFI	2727E	3627E	4527E	5427E	Drawer cabinets UNI	Workshop trolleys	Workbenches		Workshop cabinets		Perfo systems		Holders for tools	Plastic bins	Computer cabinets	Fire extinguishers	Surface treatment
dimensional line	3636E	4536E	5436E	ALCERA			ALPEDE	system	universal	mobile	ALSOR	ALNAK					

Drawer cabinets PROFI



The PROFI line drawer cabinets are intended for every day hard using at production plants and services. We offer seven basic heights, four widths and two depths. The bodies are constructed as solid weldments. The bodies are standardly furnished with a central locking system of drawers with a blocation of opening several drawers together which secures them against overturning. Inside the bodies there are inbuilt mouldings for installation of sockets in 1U raster or of shelves in 25 mm raster. The bottom parts of the bodies are furnished with slots for a wheelframe installation or for anchoring the bodies to the floor. In the upper parts there are slots for connection with a workbench or with a putting surface with rubber filler and frame.

The standard cabinet's assortment is prepared for installation of drawers of widths 27E, 36E, 45E and 54E and of depths 27E and 36E where the basic unit of length is 1E = 17 mm. The drawers are perforated along their sides in 1E = 17 mm raster. This perforation is intended for installation of metal divider sets. The drawers are offered in 5 heights from 2U to 6U where the basic unit of height is 1U = 44,45 mm. This dimension comes from the standardized height of components of 19" rack distributors. Thanks to this the drawer cabinets can be used not only for storing tools and materials, but also it is possible to inbuilt socket mouldings and electronic or 19" air devices into their bodies. In the standard assortment there are also combined versions of cabinets furnished both with drawers and doors. In case you won't find any convenient product in our standard assortment, you can use our individual programme and a wide assortment of accessories. We will be glad to set a product just according to your needs.

Standard programme

In the standard programme section we offer for each of dimensional version of the PROFI line cabinets a lot of already configured basic products. The prices of particular items are given for all available versions of slide-rails with three levels of carrying capacity and 80% or 100% telescopic drawers. The cabinets can be further furnished with items from the individual accessories assortment.

Individual programme

In case you won't find any convenient product in our standard assortment, you can use our individual programme and a wide assortment of accessories. We will be glad to set a product just according to your needs.

Slide-rails

The drawers are guided in massive slide-rails Fullterer. These slide-rails are characteristic by an easy and silent running. They are available in three versions:

- 1 Sliding 80%, drawer's carrying capacity 90 kg
- 2 Sliding 100%, drawer's carrying capacity 65 kg
- 3 Sliding 100%, drawer's carrying capacity 180 kg

ESD version

For an extra charge you can order drawer cabinets with ESD surface treatment. The extra charge is calculated individually according to the chosen cabinets and their number.

Damping

We are among the first producers who can offer you a comfort system of damped closing of drawers. It is a patented system of blocation the opening of several drawers at the same time. This extra charged system is functional for drawer's weighting up to 70 kg.

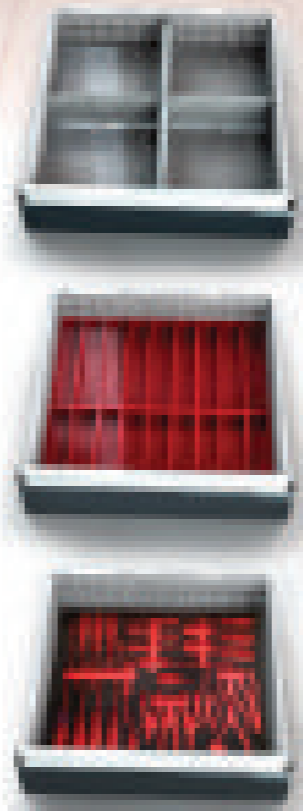

dimensional line	2727E	3627E	4527E	5427E
	3636E	4536E	5436E	

Drawer cabinets UNI

Workshop trolleys

Workbenches	
ALCERA	ALPEDE
ALSOR	ALNAK

Workshop cabinets	
system	universal
warehouse	

Perfo systems	
mobile	stationary

Holders for tools

Plastic bins

Computer cabinets

Fire extinguishers

Surface treatment

Individual programme, accessories dimensional line 2727E

Body for drawers installation

Order code	Height	max. load (kg)	Price (€)
DKP KZ 2727 3U	218	138	117,4,-
DKP KZ 2727 6U	351	271	205,9,-
DKP KZ 2727 13U	662	582	212,6,-
DKP KZ 2727 17U	840	760	228,0,-
DKP KZ 2727 21U	1018	938	287,5,-
DKP KZ 2727 26U	1240	1160	362,4,-
DKP KZ 2727 29U	1373	1293	404,5,-

Equipment of body intended for installation of drawers:

- The body is furnished with a central locking system (cylindrical lock) with an integrated function which blocks the opening of several drawers together - it's a protection against overturning.
- The bottom part of the body is furnished with slots for anchoring to the floor. We recommend anchoring the cabinet in case it will be loaded to the limit of its maximum max. load.
- Assembly mouldings on the inner part of bodies allow installing drawers in 1U = 44,45 mm raster.
- Into the body there can be mounted a holder of 19" rack accessories, a stopping device, a leading out moulding for cables and hoses and an output slot. You can also install a panel with slots for cables.
- The cabinet in 13U version is furnished with assembling slots with a reinforcement for installation of a wheelframe and a handle.

Body for doors installation

Order code	Height	max. load (kg)	Price (€)
DKP KD 2727 13U	662	582	178,6,-
DKP KD 2727 17U	840	760	193,9,-

Equipment of body intended for installation of doors:

- The body is furnished with assembling slots intended for installation of shelves in 25 mm raster.
- The cabinet in 13U version is furnished with assembling slots with a reinforcement for installation of a wheelframe and a handle.



Shelves

Order code	Price (€)
DKP PO 2727E	35,7,-

Surface max. load of the shelf is 50 kg, it is adjustable after 25 mm.



Wheelframe

Order code		Price (€)
DKP MGP 27E	rubber castors	122,9,-
DKP MPP 27E	PP castors	212,3,-

Extra charge equipment of the 13U cabinets. Castors with diameter 100 mm, 2x fixed castor a 2x revolving castor with a brake.

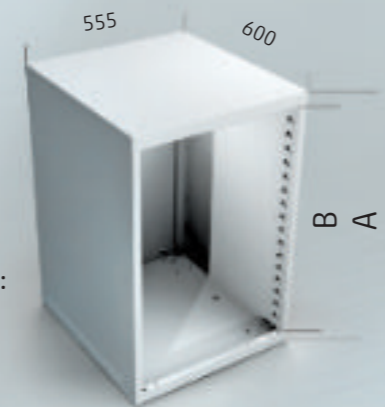

Doors

The doors are furnished with a comfort aluminium handle with a groove allowing to insert a label. On the inner part of the dooring there is a reinforcing item with EUROPERFO® slots intended for installation of holders for tools. Locking by cylindrical locks. Unlocking doors are magnetically kept in closed position.

Order code		Price (€)
DKP DV 27E 9U P	1	55,1,-
DKP DV 27E 13U P	1	57,2,-
DKP DV 27E 13U	2	41,2,-
DKP DV 27E 17U	2	42,5,-

Upper putting surface

Order code	Price (€)
DKP HPR 2727	34,4,-

For an extra charge the body can be furnished with a putting surface with 5 mm width foam filling and with a 20 mm high frame. This frame is a protection against falling of small objects.



Damping

Order code	Price (€)
TSI 80	35,9,-

The drawers of the DKP line cabinets can be furnished for an extra charge with a system of damped closing. This system is intended for drawers with maximum weighting up to 70 kg. A high quality gas damper ensures secure running and a long lifetime of the system.

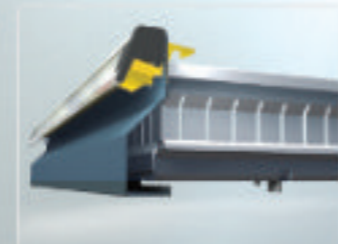

Safety pin for drawers

Order code	Price (€)
DKP PVZ	7,8,-

For an extra charge the drawers can be furnished with a safety pin which secures them closed. This is useful especially for mobile cabinets. In case of going on a slant surface with unlocked drawers it keeps them closed.

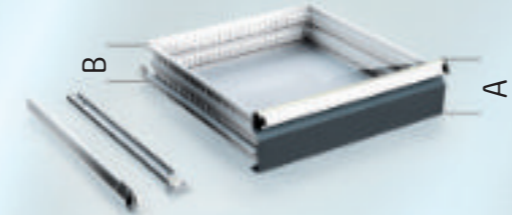

Drawers 2727E, sliding 80%, max. load 90 kg

Order code	Front's height	Side's height	Price (€)
DKP Z 2727 2U A	85	58	81,7,-
DKP Z 2727 3U A	129	102	88,4,-
DKP Z 2727 4U A	174	147	95,3,-
DKP Z 2727 5U A	218	191	102,1,-
DKP Z 2727 6U A	263	236	108,9,-

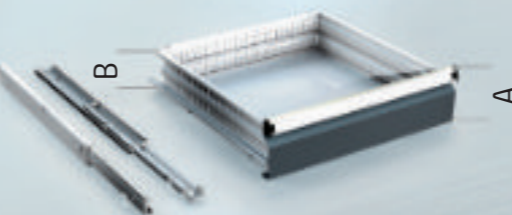

Drawers 2727E, sliding 100%, max. load 65 kg

Order code	Front's height	Side's height	Price (€)
DKP Z 2727 2U B	85	58	112,9,-
DKP Z 2727 3U B	129	102	119,8,-
DKP Z 2727 4U B	174	147	126,5,-
DKP Z 2727 5U B	218	191	133,4,-
DKP Z 2727 6U B	263	236	140,2,-

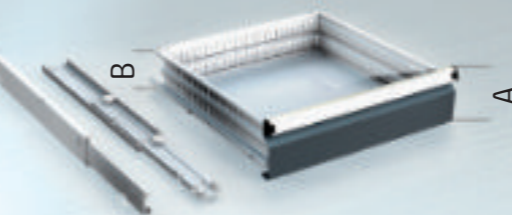

Drawers 2727E, sliding 100%, max. load 180 kg

Order code	Front's height	Side's height	Price (€)
DKP Z 2727 3U C	129	102	160,9,-
DKP Z 2727 4U C	174	147	167,8,-
DKP Z 2727 5U C	218	191	174,5,-
DKP Z 2727 6U C	263	236	181,4,-



Perforated drawer's bottom

Order code	Price (€)
DKP PDZ 2727	6,7,-

For an extra charge the drawers can be furnished with a perforated bottom. It is useful to combine it with a metal divider set. Bars can be tightly screwed to the drawer's bottom.



PE foam filling of 5,0 mm height

Order code	Price (€)
DKP PVZ 2727	7,4,-

The foam filling is an efficient protection of gauges and other sensitive devices against their damage.

Divider sets for drawers



Order code	Price (€)
DMZ 2727 2U 4P	12,5,-
DMZ 2727 3U 4P	18,0,-
DMZ 2727 5U 4P	25,5,-

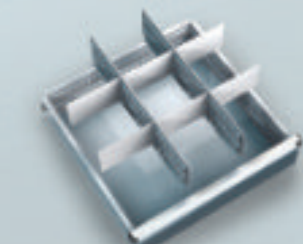

Order code	Price (€)
DMZ 2727 2U 9P	24,6,-
DMZ 2727 3U 9P	35,9,-
DMZ 2727 5U 9P	51,0,-

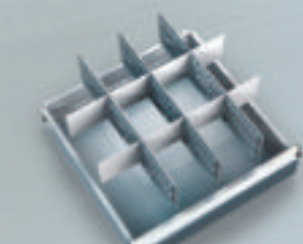

Order code	Price (€)
DMZ 2727 2U 12P	32,6,-
DMZ 2727 3U 12P	47,2,-
DMZ 2727 5U 12P	64,9,-



The divider set of the 27E x 27E drawer allows dividing the drawer's inner part into 4 pieces. It contains 1x perforated dividing bar 27E, 1x bar 13E and 1x bar 14E.

The 3U divider set is intended for drawers 3U and 4U, the 5U divider set is intended for drawers 5U and 6U.

The divider set of the 27E x 27E drawer allows dividing the drawer's inner part into 9 pieces. It contains 2x perforated dividing bar 27E and 9x bar 9E.

The 3U divider set is intended for drawers 3U and 4U, the 5U divider set is intended for drawers 5U and 6U.

The divider set of the 27E x 27E drawer allows dividing the drawer's inner part into 12 pieces. It contains 3x perforated dividing bar 27E, 6x bar 7E and 2x bar 6E.

The 3U divider set is intended for drawers 3U and 4U, the 5U divider set is intended for drawers 5U and 6U.

Plastic bins

The plastic bins are intended for dividing the inner drawer's part. On pages 92 and 93 of this catalogue you can find the complete assortment of already configured sets of bins designed directly for particular dimensional lines of drawers. In case that any of those sets do not suit you it is possible to create an individual set. Components for creating the set you will find on page 88.



Individual foam filling of drawer

We are able to produce customized foam fillings according to customer's requirement and given electronic drawings. Minimum order number is 20 pcs.



Order code	Description	Price (€)
DK PK	bar of the E cabinet	43,9,-
DK D1U	holder 1U, a pair incl. cage nuts M6 and screws	5,8,-
DK D2U	holder 2U, a pair incl. cage nuts M6 and screws	6,8,-
DK D3U	holder 3U, a pair incl. cage nuts M6 and screws	8,5,-
DK K1U	cover 1U full	4,1,-
DK K2U	cover 2U full	5,5,-
DK K3U	cover 3U full	6,8,-
DK KV1U	cover 1U, cut according to customer's specification	5,5,-
DK KV2U	cover 2U, cut according to customer's specification	6,8,-
DK KV3U	cover 3U, cut according to customer's specification	8,1,-
DK VYL	leading moulding for cabinet DK 2727	5,8,-
DK PR3	cover with a slot for cables divided for 3 cables or hoses	8,1,-
Z7V 19 1U	socket moulding with a switch and 7 sockets without overvoltage protection	128,3,-
RS	coupler for compressed air	17,-

Standard programme dimensional line 2727E

- The body is furnished with a central locking system (cylindrical lock) with an integrated function which blocks the opening of several drawers together - it's a protection against overturning. The bottom part of the body is furnished with slots for anchoring to the floor. We recommend anchoring the cabinet in case it will be loaded to the limit of its maximum carrying capacity.
- Assembly mouldings on the inner part of bodies allow installing drawers in 1U = 44,45 mm raster.
- Into the body there can be mounted a holder of 19" rack accessories, a stopping device, a leading out moulding for cables and hoses and an output slot. You can also install a panel with slots for cables.

Cabinets for modular workbenches

Order code	Shelves (pc)	Sliding	Price (€)
DKP 2727 13U 1D	1		255,5,-
DKP 2727 13U 1ZAD	1	80%	357,9,-
DKP 2727 13U 1ZBD	1	100%	389,2,-
DKP 2727 13U 4AA		80%	573,3,-
DKP 2727 13U 4AB		100%	698,5,-
DKP 2727 13U 4KA EH		80%	714,5,-
DKP 2727 13U 4KB EH		100%	839,7,-
DKP 2727 13U 3KA EVH		80%	685,6,-
DKP 2727 13U 3KA EVH		100%	779,5,-

Hanging cabinets for workbenches

Order code	Sliding	Price (€)
DKP 2727 3U 1AA	80%	205,9,-
DKP 2727 3U 1AB	100%	237,1,-
DKP 2727 6U 2AA	80%	382,8,-
DKP 2727 6U 2AB	100%	445,3,-
DKP 2727 6U 2BA	80%	382,8,-
DKP 2727 6U 2BB	100%	445,3,-
DKP 2727 6U 3AA	80%	450,8,-
DKP 2727 6U 3AB	100%	544,7,-
DKP 2727 6U 2KA ED	80%	523,9,-
DKP 2727 6U 2KB ED	100%	586,6,-

Mobile cabinets

Order code	Shelves (pc)	Sliding	Price (€)
DKP 2727 13U 1D RPM	1		412,7,-
DKP 2727 13U 1ZAD RPM	1	80%	515,2,-
DKP 2727 13U 1ZBD RPM	1	100%	546,5,-
DKP 2727 13U 3AA RPM		80%	662,5,-
DKP 2727 13U 3AB RPM		100%	756,4,-
DKP 2727 13U 4AA RPM		80%	730,5,-
DKP 2727 13U 4AB RPM		100%	855,7,-
DKP 2727 13U 4KA RPM EH		80%	871,7,-
DKP 2727 13U 4KB RPM EH		100%	997,-
DKP 2727 13U 3KA RPM EVH		80%	842,8,-
DKP 2727 13U 3KB RPM EVH		100%	936,8,-

Standard programme dimensional line 2727E

Cabinets for workbenches 17U



Order code	Shelves (pc)	Price (€)
DKP 2727 17U 1D	1	307,9,-



Order code	Shelves (pc)	Sliding	Price (€)
DKP 2727 17U 1ZAD	1	80% - 90 kg	375,2,-
DKP 2727 17U 1ZBD	1	100% - 65 kg	406,5,-



Order code	Sliding	Price (€)
DKP 2727 17U 3AA	80% - 90 kg	547,7,-
DKP 2727 17U 3AB	100% - 65 kg	641,6,-
DKP 2727 17U 3AC	100% - 180 kg	765,1,-



Order code	Sliding	Price (€)
DKP 2727 17U 4AA	80% - 90 kg	615,7,-
DKP 2727 17U 4AB	100% - 65 kg	741,0,-
DKP 2727 17U 4AC	100% - 180 kg	905,6,-

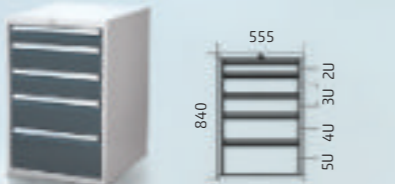

Order code	Sliding	Price (€)
DKP 2727 17U 5AA	80% - 90 kg	683,8,-
DKP 2727 17U 5AB	100% - 65 kg	840,3,-



Order code	Sliding	Price (€)
DKP 2727 17U 5KA EH	80% - 90 kg	825,0,-
DKP 2727 17U 5KB EH	100% - 65 kg	981,4,-



Order code	Sliding	Price (€)
DKP 2727 17U 4KA EVH	80% - 90 kg	790,6,-
DKP 2727 17U 4KB EVH	100% - 65 kg	915,8,-

Drawer cabinets 21U



Order code	Sliding	Price (€)
DKP 2727 21U 4AA	80% - 90 kg	702,5,-
DKP 2727 21U 4AB	100% - 65 kg	827,7,-
DKP 2727 21U 4AC	100% - 180 kg	992,4,-



Order code	Sliding	Price (€)
DKP 2727 21U 5AA	80% - 90 kg	777,4,-
DKP 2727 21U 5AB	100% - 65 kg	927,0,-
DKP 2727 21U 5AC	100% - 180 kg	1139,7,-



Order code	Sliding	Price (€)
DKP 2727 21U 6AA	80% - 90 kg	838,6,-
DKP 2727 21U 6AB	100% - 65 kg	1026,4,-



Order code	Sliding	Price (€)
DKP 2727 21U 7AA	80% - 90 kg	906,6,-
DKP 2727 21U 7AB	100% - 65 kg	1125,7,-



Order code	Sliding	Price (€)
DKP 2727 21U 6KA EH	80% - 90 kg	979,8,-
DKP 2727 21U 6KB EH	100% - 65 kg	1167,5,-



Order code	Sliding	Price (€)
DKP 2727 21U 6LA EVH	80% - 90 kg	1013,4,-
DKP 2727 21U 6LB EVH	100% - 65 kg	1201,2,-

Drawer cabinets 26U



Order code	Sliding	Price (€)
DKP 2727 26U 5AA	80% - 90 kg	879,4,-
DKP 2727 26U 5AB	100% - 65 kg	1035,9,-
DKP 2727 26U 5AC	100% - 180 kg	1241,7,-



Order code	Sliding	Price (€)
DKP 2727 26U 6AA	80% - 90 kg	947,5,-
DKP 2727 26U 6AB	100% - 65 kg	1135,2,-
DKP 2727 26U 6AC	100% - 180 kg	1382,2,-



Order code	Sliding	Price (€)
DKP 2727 26U 7AA	80% - 90 kg	1015,5,-
DKP 2727 26U 7AB	100% - 65 kg	1234,6,-



Order code	Sliding	Price (€)
DKP 2727 26U 8AA	80% - 90 kg	1083,5,-
DKP 2727 26U 8AB	100% - 65 kg	1333,9,-



Order code	Sliding	Price (€)
DKP 2727 26U 7KA EH	80% - 90 kg	1156,7,-
DKP 2727 26U 7KB EH	100% - 65 kg	1375,7,-



Order code	Sliding	Price (€)
DKP 2727 26U 7LA EVH	80% - 90 kg	1190,4,-
DKP 2727 26U 7LB EVH	100% - 65 kg	1409,5,-

Drawer cabinets 29U



Order code	Sliding	Price (€)
DKP 2727 29U 6AA	80% - 90 kg	1010,0,-
DKP 2727 29U 6AB	100% - 65 kg	1197,9,-
DKP 2727 29U 6AC	100% - 180 kg	1444,8,-

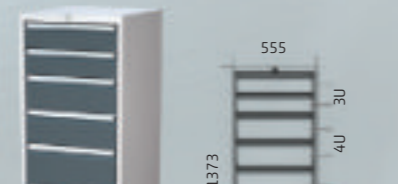

Order code	Sliding	Price (€)
DKP 2727 29U 7AA	80% - 90 kg	1078,1,-
DKP 2727 29U 7AB	100% - 65 kg	1297,2,-
DKP 2727 29U 7AC	100% - 180 kg	1585,3,-



Order code	Sliding	Price (€)
DKP 2727 29U 8AA	80% - 90 kg	1146,2,-
DKP 2727 29U 8AB	100% - 65 kg	1396,5,-



Order code	Sliding	Price (€)
DKP 2727 29U 9AA	80% - 90 kg	1214,2,-
DKP 2727 29U 9AB	100% - 65 kg	1495,9,-



Order code	Sliding	Price (€)
DKP 2727 29U 8KA EH	80% - 90 kg	1294,1,-
DKP 2727 29U 8KB EH	100% - 65 kg	1544,5,-



Order code	Sliding	Price (€)
DKP 2727 29U 8LA EVH	80% - 90 kg	1321,0,-
DKP 2727 29U 8LB EVH	100% - 65 kg	1571,4,-

Individual programme, accessories dimensional line 3627E

Body for drawers installation

Order code	Height	Carrying capacity (kg)	Price (€)
DKP KZ 3627 17	840	760	243,9,-
DKP KZ 3627 21	1018	938	307,6,-
DKP KZ 3627 26U	1240	1160	387,6,-
DKP KZ 3627 29U	1373	1293	432,8,-
	A	B	

Equipment of body intended for installation of drawers:

- The body is furnished with a central locking system (cylindrical lock) with an integrated function which blocks the opening of several drawers together - it's a protection against overturning.
- The bottom part of the body is furnished with slots for anchoring to the floor. We recommend anchoring the cabinet in case it will be loaded to the limit of its maximum carrying capacity.
- Assembly mouldings on the inner part of bodies allow installing drawers in 1U = 44,45 mm raster.
- Into the body there can be mounted a holder of 19" rack accessories, a stopping device, a leading out moulding for cables and hoses and an output slot. You can also install a panel with slots for cables.

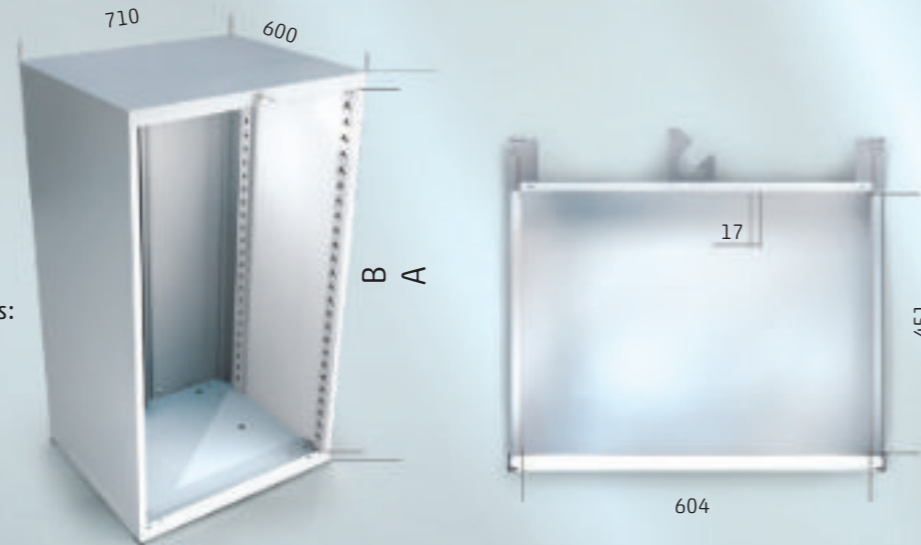

Drawers 3627E, sliding 80%, carrying capacity 90 kg

Order code	Front's height	Side's height	Price (€)
DKP Z 3627 2U A	85	58	86,5,-
DKP Z 3627 3U A	129	102	93,8,-
DKP Z 3627 4U A	174	147	101,0,-
DKP Z 3627 5U A	218	191	108,1,-
DKP Z 3627 6U A	263	236	115,4,-
	A	B	

The drawers are guided in massive slide-rails Futlerer with four ball bearings. These slide-rails are characteristic by an easy and silent running.

The drawers are furnished with a comfort aluminium handle with an installed holder of a safety pin DKP PVZ and with a groove for a label with drawer's contents.

The inner parts of the drawers are pressed and grooved for installing of metal divider sets. Groove spacing is 1E = 17 mm. Useable drawer plan is 604 x 451 mm.

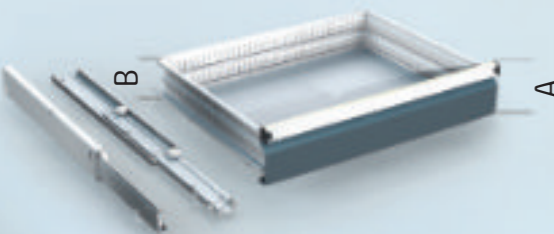

Drawers 3627E, sliding 100%, carrying capacity 180 kg

Order code	Front's height	Side's height	Price (€)
DKP Z 3627 3U C	129	102	166,2,-
DKP Z 3627 4U C	174	147	173,4,-
DKP Z 3627 5U C	218	191	180,6,-
DKP Z 3627 6U C	263	236	187,8,-
	A	B	

The drawers are guided in massive slide-rails Futlerer with ten pulleys. These slide-rails are characteristic by an easy and silent running.

The drawers are furnished with a comfort aluminium handle with an installed holder of a safety pin DKP PVZ and with a groove for a label with drawer's contents.

The inner parts of the drawers are pressed and grooved for installing of metal divider sets. Groove spacing is 1E = 17 mm. Useable drawer plan is 604 x 451 mm.

Drawers 3627E, sliding 100%, carrying capacity 65 kg

Order code	Front's height	Side's height	Price (€)
DKP Z 3627 2U B	85	58	117,9,-
DKP Z 3627 3U B	129	102	125,0,-
DKP Z 3627 4U B	174	147	132,2,-
DKP Z 3627 5U B	218	191	139,5,-
DKP Z 3627 6U B	263	236	146,7,-
	A	B	

The drawers are guided in massive slide-rails Futlerer with ten pulleys. These slide-rails are characteristic by an easy and silent running.

The drawers are furnished with a comfort aluminium handle with an installed holder of a safety pin DKP PVZ and with a groove for a label with drawer's contents.

The inner parts of the drawers are pressed and grooved for installing of metal divider sets. Groove spacing is 1E = 17 mm. Useable drawer plan is 604 x 451 mm.

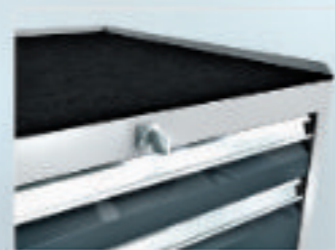

Upper putting surface

Order code	Price (€)
DKP HPR 3627	36,7,-

For an extra charge the body can be furnished with a putting surface with 5 mm width foam filling and with a 20 mm high frame. This frame is a protection against falling of small objects.



Pallet base

Order code	Price (€)
DKP PMP 3627	91,8,-

The pallet base makes the cabinet's manipulation easier.

Divider sets for drawers

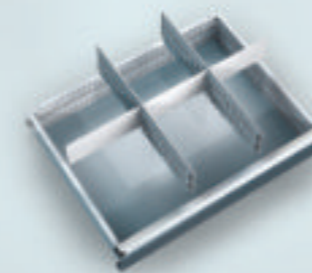

Order code	Price (€)
DMZ 3627 2U 6P	22,0,-
DMZ 3627 3U 6P	31,5,-
DMZ 3627 5U 6P	43,3,-

The divider set of the 36E x 27E drawers allows dividing the drawer's inner part into 6 pieces. It contents 2x perforated dividing bar 27E and 3x bar 12E.

The 3U divider set is intended for drawers 3U and 4U, the 5U divider set is intended for drawers 5U and 6U.

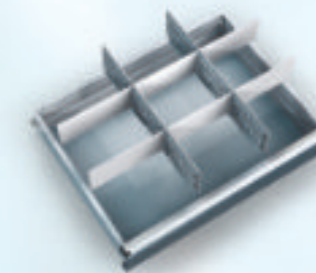

Order code	Price (€)
DMZ 3627 2U 9P	27,5,-
DMZ 3627 3U 9P	40,0,-
DMZ 3627 5U 9P	57,9,-

The divider set of the 36E x 27E drawers allows dividing the drawer's inner part into 9 pieces. It contents 2x perforated dividing bar 27E and 6x bar 12E.

The 3U divider set is intended for drawers 3U and 4U, the 5U divider set is intended for drawers 5U and 6U.

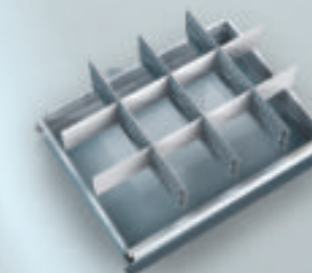

Order code	Price (€)
DMZ 3627 2U 12P	35,6,-
DMZ 3627 3U 12P	51,7,-
DMZ 3627 5U 12P	72,8,-

The divider set of the 36E x 27E drawers allows dividing the drawer's inner part into 12 pieces. It contents 3x perforated dividing bar 27E and 8x bar 9E.

The 3U divider set is intended for drawers 3U and 4U, the 5U divider set is intended for drawers 5U and 6U.

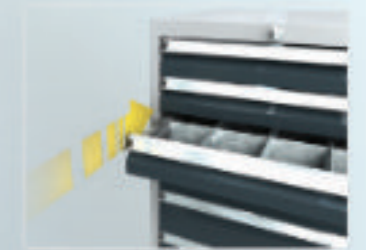

Damping

Order code	Price (€)
TSI 80	35,9,-

The drawers of the DKP line cabinets can be furnished for an extra charge with a system of damped closing. This system is intended for drawers with maximum weighting up to 70 kg. A high quality gas damper ensures secure running and a long lifetime of the system.

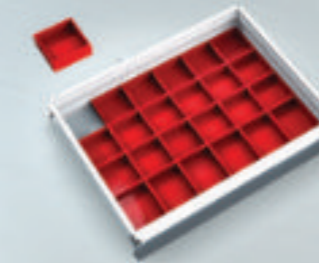
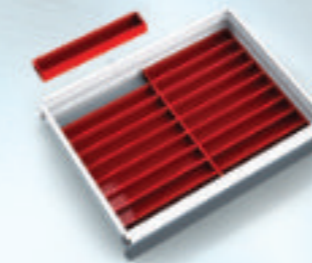

Plastic bins

The plastic bins are intended for dividing the inner drawer's part. On pages 92 and 93 of this catalogue you can find the complete assortment of already configured sets of bins designed directly for particular dimensional lines of drawers. In case that any of those sets do not suit you it is possible to create an individual set. Components for creating the set you will find on page 88.



Perforated drawer's bottom

Order code	Price (€)
DKP PDZ 3627	7,1,-

For an extra charge the drawers can be furnished with a perforated bottom. It is useful to combine it with a metal divider set. Bars can be tightly screwed to the drawer's bottom.



PE foam filling of 5,0 mm height

Order code	Price (€)
DKP PVZ 3627	10,0,-

The foam filling is an efficient protection of gauges and other sensitive devices against their damage.



Individual foam filling of drawer

We are able to produce customized foam fillings according to customer's requirement and given electronic drawings. Minimum order number is 20 pcs.

Standard programme dimensional line 3627E

Drawer cabinets 17U

Order code	Sliding	Price (€)
DKP 3627 17U 3AA	80% - 90 kg	582,8,-
DKP 3627 17U 3AB	100% - 65 kg	676,7,-
DKP 3627 17U 3AC	100% - 180 kg	800,2,-

Order code	Sliding	Price (€)
DKP 3627 17U 4AA	80% - 90 kg	658,0,-
DKP 3627 17U 4AB	100% - 65 kg	780,1,-

Order code	Sliding	Price (€)
DKP 3627 17U 5AA	80% - 90 kg	727,1,-
DKP 3627 17U 5AB	100% - 65 kg	883,5,-

Order code	Sliding	Price (€)
DKP 3627 17U 6AA	80% - 90 kg	799,2,-
DKP 3627 17U 6AB	100% - 65 kg	987,0,-

Order code	Sliding	Price (€)
DKP 3627 17U 7AA	80% - 90 kg	871,3,-
DKP 3627 17U 7AB	100% - 65 kg	1090,4,-

Order code	Sliding	Price (€)
DKP 3627 17U 8AA	80% - 90 kg	943,5,-
DKP 3627 17U 8AB	100% - 65 kg	1193,8,-

Drawer cabinets 21U

Order code	Sliding	Price (€)
DKP 3627 21U 4AA	80% - 90 kg	747,5,-
DKP 3627 21U 4AB	100% - 65 kg	872,7,-
DKP 3627 21U 4AC	100% - 180 kg	1037,3,-

Order code	Sliding	Price (€)
DKP 3627 21U 5AA	80% - 90 kg	819,6,-
DKP 3627 21U 5AB	100% - 65 kg	976,1,-
DKP 3627 21U 5AC	100% - 180 kg	1181,9,-

Order code	Sliding	Price (€)
DKP 3627 21U 6AA	80% - 90 kg	891,8,-
DKP 3627 21U 6AB	100% - 65 kg	1079,5,-

Order code	Sliding	Price (€)
DKP 3627 21U 7AA	80% - 90 kg	963,8,-
DKP 3627 21U 7AB	100% - 65 kg	1182,9,-

Order code	Sliding	Price (€)
DKP 3627 21U 8AA	80% - 90 kg	1036,0,-
DKP 3627 21U 8AB	100% - 65 kg	1286,3,-

Order code	Sliding	Price (€)
DKP 3627 21U 9AA	80% - 90 kg	1108,1,-
DKP 3627 21U 9AB	100% - 65 kg	1389,8,-

Drawer cabinets 26U

Order code	Sliding	Price (€)
DKP 3627 26U 5AA	80% - 90 kg	935,7,-
DKP 3627 26U 5AB	100% - 65 kg	1092,2,-
DKP 3627 26U 5AC	100% - 180 kg	1298,0,-

Order code	Sliding	Price (€)
DKP 3627 26U 6AA	80% - 90 kg	1007,9,-
DKP 3627 26U 6AB	100% - 65 kg	1195,6,-
DKP 3627 26U 6AC	100% - 180 kg	1442,6,-

Order code	Sliding	Price (€)
DKP 3627 26U 7AA	80% - 90 kg	1080,0,-
DKP 3627 26U 7AB	100% - 65 kg	1299,1,-

Order code	Sliding	Price (€)
DKP 3627 26U 8AA	80% - 90 kg	1152,1,-
DKP 3627 26U 8AB	100% - 65 kg	1402,5,-

Order code	Sliding	Price (€)
DKP 3627 26U 9AA	80% - 90 kg	1224,2,-
DKP 3627 26U 9AB	100% - 65 kg	1505,9,-

Order code	Sliding	Price (€)
DKP 3627 26U 10AA	80% - 90 kg	1296,4,-
DKP 3627 26U 10AB	100% - 65 kg	1609,3,-

Drawer cabinets 29U

Order code	Sliding	Price (€)
DKP 3627 29U 6AA	80% - 90 kg	1074,6,-
DKP 3627 29U 6AB	100% - 65 kg	1262,4,-
DKP 3627 29U 6AC	100% - 180 kg	1509,3,-

Order code	Sliding	Price (€)
DKP 3627 29U 7AA	80% - 90 kg	1146,8,-
DKP 3627 29U 7AB	100% - 65 kg	1365,8,-
DKP 3627 29U 7AC	100% - 180 kg	1653,9,-

Order code	Sliding	Price (€)
DKP 3627 29U 8AA	80% - 90 kg	1218,8,-
DKP 3627 29U 8AB	100% - 65 kg	1469,2,-

Order code	Sliding	Price (€)
DKP 3627 29U 9AA	80% - 90 kg	1291,0,-
DKP 3627 29U 9AB	100% - 65 kg	1572,6,-

Order code	Sliding	Price (€)
DKP 3627 29U 10AA	80% - 90 kg	1363,1,-
DKP 3627 29U 10AB	100% - 65 kg	1676,0,-

Order code	Sliding	Price (€)
DKP 3627 29U 11AA	80% - 90 kg	1435,2,-
DKP 3627 29U 11AB	100% - 65 kg	1779,4,-

Individual programme, accessories dimensional line 4527E

Body for drawers installation

Order code	Height	Carrying capacity (kg)	Price (€)
DKP KZ 4527 17U	840	760	263,4,-
DKP KZ 4527 21U	1018	938	332,2,-
DKP KZ 4527 26U	1240	1160	418,7,-
DKP KZ 4527 29U	1373	1293	467,4,-
	A	B	

Equipment of body intended for installation of drawers:

- The body is furnished with a central locking system (cylindrical lock) with an integrated function which blocks the opening of several drawers together - it's a protection against overturning.
- The bottom part of the body is furnished with slots for anchoring to the floor. We recommend anchoring the cabinet in case it will be loaded to the limit of its maximum carrying capacity.
- Assembly mouldings on the inner part of bodies allow installing drawers in 1U = 44,45 mm raster.
- Into the body there can be mounted a holder of 19" rack accessories, a stopping device, a leading out moulding for cables and hoses and an output slot. You can also install a panel with slots for cables.

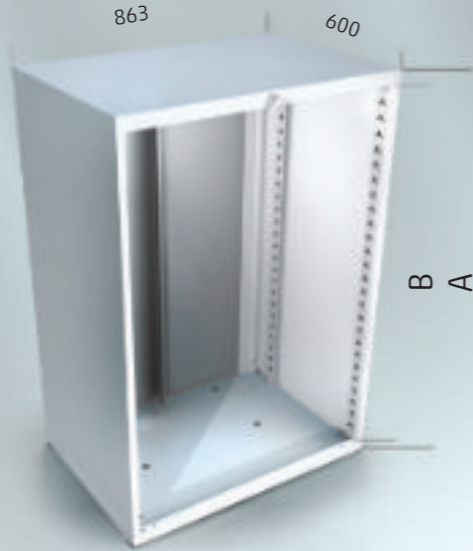

Drawers 4527E, sliding 80%, carrying capacity 90 kg

Order code	Front's height	Side's height	Price (€)
DKP Z 4527 2U A	85	58	92,6,-
DKP Z 4527 3U A	129	102	100,3,-
DKP Z 4527 4U A	174	147	108,0,-
DKP Z 4527 5U A	218	191	115,8,-
DKP Z 4527 6U A	263	236	123,5,-
	A	B	

The drawers are guided in massive slide-rails Fullterer with four ball bearings. These slide-rails are characteristic by an easy and silent running. The drawers are furnished with a comfort aluminium handle with an installed holder of a safety pin DKP PVZ and with a groove for a label with drawer's contents. The inner parts of the drawers are pressed and grooved for installing of metal divider sets. Groove spacing is 1E = 17 mm. Useable drawer plan is 757 x 451 mm.



Drawers 4527E, sliding 100%, carrying capacity 65 kg

Order code	Front's height	Side's height	Price (€)
DKP Z 4527 2U B	85	58	123,9,-
DKP Z 4527 3U B	129	102	131,6,-
DKP Z 4527 4U B	174	147	139,4,-
DKP Z 4527 5U B	218	191	147,0,-
DKP Z 4527 6U B	263	236	154,8,-
	A	B	

The drawers are guided in massive slide-rails Fullterer with ten pulleys. These slide-rails are characteristic by an easy and silent running. The drawers are furnished with a comfort aluminium handle with an installed holder of a safety pin DKP PVZ and with a groove for a label with drawer's contents. The inner parts of the drawers are pressed and grooved for installing of metal divider sets. Groove spacing is 1E = 17 mm. Useable drawer plan is 757 x 451 mm.



Drawers 4527E, sliding 100%, carrying capacity 180 kg

Order code	Front's height	Side's height	Price (€)
DKP Z 4527 3U C	129	102	172,7,-
DKP Z 4527 4U C	174	147	180,5,-
DKP Z 4527 5U C	218	191	188,2,-
DKP Z 4527 6U C	263	236	195,9,-
	A	B	

The drawers are guided in massive slide-rails Fullterer with ten pulleys. These slide-rails are characteristic by an easy and silent running. The drawers are furnished with a comfort aluminium handle with an installed holder of a safety pin DKP PVZ and with a groove for a label with drawer's contents. The inner parts of the drawers are pressed and grooved for installing of metal divider sets. Groove spacing is 1E = 17 mm. Useable drawer plan is 757 x 451 mm.

Divider sets for drawers

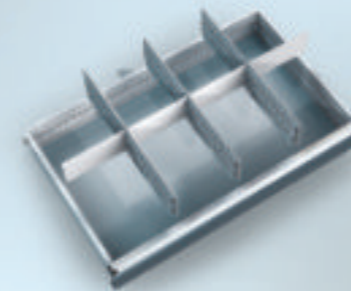

Order code	Price (€)
DMZ 4527 2U 8P	31,6,-
DMZ 4527 3U 8P	45,1,-
DMZ 4527 5U 8P	61,3,-

The divider set of the 45E x 27E drawers allows dividing the drawer's inner part into 8 pieces. It contains 3x perforated dividing bar 27E, 3x bar 12E and 1x bar 9E.

The 3U divider set is intended for drawers 3U and 4U, the 5U divider set is intended for drawers 5U and 6U.

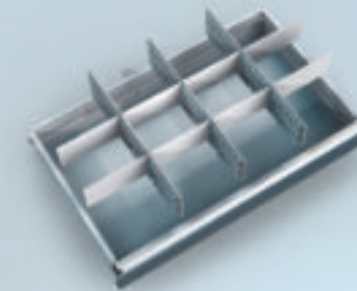

Order code	Price (€)
DMZ 4527 2U 12P	38,5,-
DMZ 4527 3U 12P	55,8,-
DMZ 4527 5U 12P	79,7,-

The divider set of the 45E x 27E drawers allows dividing the drawer's inner part into 12 pieces. It contains 3x perforated dividing bar 27E, 6x bar 12E and 2x bar 9E.

The 3U divider set is intended for drawers 3U and 4U, the 5U divider set is intended for drawers 5U and 6U.

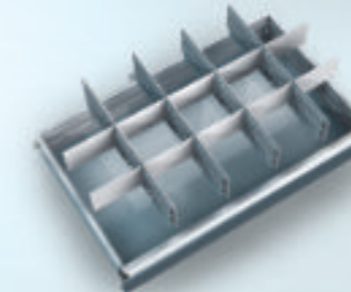

Order code	Price (€)
DMZ 4527 2U 15P	46,6,-
DMZ 4527 3U 15P	67,5,-
DMZ 4527 5U 15P	94,5,-

The divider set of the 45E x 27E drawers allows dividing the drawer's inner part into 15 pieces. It contains 4x perforated dividing bar 27E and 10x bar 9E.

The 3U divider set is intended for drawers 3U and 4U, the 5U divider set is intended for drawers 5U and 6U.



Perforated drawer's bottom

Order code	Price (€)
DKP PDZ 4527	7,6,-

For an extra charge the drawers can be furnished with a perforated bottom. It is useful to combine it with a metal divider set. Bars can be tightly screwed to the drawer's bottom.



Damping

Order code	Price (€)
TSI 80	35,9,-

The drawers of the DKP line cabinets can be furnished for an extra charge with a system of damped closing. This system is intended for drawers with maximum weighting up to 70 kg. A high quality gas damper ensures secure running and a long lifetime of the system.

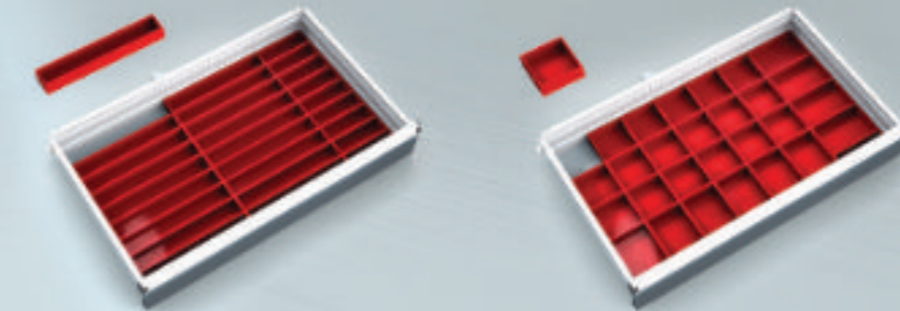

Plastic bins

The plastic bins are intended for dividing the inner drawer's part. On pages 92 and 93 of this catalogue you can find the complete assortment of already configured sets of bins designed directly for particular dimensional lines of drawers. In case that any of those sets do not suit you it is possible to create an individual set. Components for creating the set you will find on page 88.

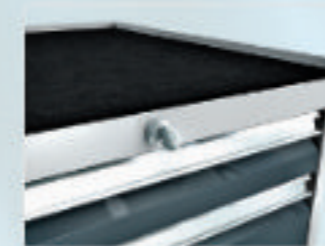

Upper putting surface

Order code	Price (€)
DKP HPR 4527	39,7,-

For an extra charge the body can be furnished with a putting surface with 5 mm width foam filling and with a 20 mm high frame. This frame is a protection against falling of small objects.



Pallet base

Order code	Price (€)
DKP PMP 4527	99,1,-

The pallet base makes the cabinet's manipulation easier.



PE foam filling of 5,0 mm height

Order code	Price (€)
DKP PVZ 4527	14,6,-

The foam filling is an efficient protection of gauges and other sensitive devices against their damage.



Individual foam filling of drawer

We are able to produce customized foam fillings according to customer's requirement and given electronic drawings. Minimum order number is 20 pcs.

Standard programme dimensional line 4527E

Drawer cabinets 17U

Order code	Sliding	Price (€)
DKP 4527 17U 3AA	80% - 90 kg	626,0,-
DKP 4527 17U 3AB	100% - 65 kg	719,9,-
DKP 4527 17U 3AC	100% - 180 kg	843,4,-

Order code	Sliding	Price (€)
DKP 4527 17U 4AA	80% - 90 kg	703,2,-
DKP 4527 17U 4AB	100% - 65 kg	828,4,-

Order code	Sliding	Price (€)
DKP 4527 17U 5AA	80% - 90 kg	780,4,-
DKP 4527 17U 5AB	100% - 65 kg	936,9,-

Order code	Sliding	Price (€)
DKP 4527 17U 6AA	80% - 90 kg	857,6,-
DKP 4527 17U 6AB	100% - 65 kg	1045,4,-

Order code	Sliding	Price (€)
DKP 4527 17U 7AA	80% - 90 kg	934,7,-
DKP 4527 17U 7AB	100% - 65 kg	1153,8,-

Order code	Sliding	Price (€)
DKP 4527 17U 8AA	80% - 90 kg	1011,9,-
DKP 4527 17U 8AB	100% - 65 kg	1262,3,-

Drawer cabinets 21U

Order code	Sliding	Price (€)
DKP 4527 21U 4AA	80% - 90 kg	802,9,-
DKP 4527 21U 4AB	100% - 65 kg	928,1,-
DKP 4527 21U 4AC	100% - 180 kg	1092,7,-

Order code	Sliding	Price (€)
DKP 4527 21U 5AA	80% - 90 kg	880,0,-
DKP 4527 21U 5AB	100% - 65 kg	1036,5,-
DKP 4527 21U 5AC	100% - 180 kg	1242,3,-

Order code	Sliding	Price (€)
DKP 4527 21U 6AA	80% - 90 kg	957,2,-
DKP 4527 21U 6AB	100% - 65 kg	1145,0,-

Order code	Sliding	Price (€)
DKP 4527 21U 7AA	80% - 90 kg	1034,4,-
DKP 4527 21U 7AB	100% - 65 kg	1253,5,-

Order code	Sliding	Price (€)
DKP 4527 21U 8AA	80% - 90 kg	1111,6,-
DKP 4527 21U 8AB	100% - 65 kg	1361,9,-

Order code	Sliding	Price (€)
DKP 4527 21U 9AA	80% - 90 kg	1188,7,-
DKP 4527 21U 9AB	100% - 65 kg	1470,3,-

Drawer cabinets 26U

Order code	Sliding	Price (€)
DKP 4527 26U 5AA	80% - 90 kg	1005,1,-
DKP 4527 26U 5AB	100% - 65 kg	1161,5,-
DKP 4527 26U 5AC	100% - 180 kg	1367,4,-

Order code	Sliding	Price (€)
DKP 4527 26U 6AA	80% - 90 kg	1082,3,-
DKP 4527 26U 6AB	100% - 65 kg	1270,1,-
DKP 4527 26U 6AC	100% - 180 kg	1517,0,-

Order code	Sliding	Price (€)
DKP 4527 26U 7AA	80% - 90 kg	1159,5,-
DKP 4527 26U 7AB	100% - 65 kg	1378,5,-

Order code	Sliding	Price (€)
DKP 4527 26U 8AA	80% - 90 kg	1236,6,-
DKP 4527 26U 8AB	100% - 65 kg	1487,0,-

Order code	Sliding	Price (€)
DKP 4527 26U 9AA	80% - 90 kg	1313,7,-
DKP 4527 26U 9AB	100% - 65 kg	1595,4,-

Order code	Sliding	Price (€)
DKP 4527 26U 10AA	80% - 90 kg	1390,9,-
DKP 4527 26U 10AB	100% - 65 kg	1703,9,-

Drawer cabinets 29U

Order code	Sliding	Price (€)
DKP 4527 29U 6AA	80% - 90 kg	1154,1,-
DKP 4527 29U 6AB	100% - 65 kg	1342,0,-
DKP 4527 29U 6AC	100% - 180 kg	1588,9,-

Order code	Sliding	Price (€)
DKP 4527 29U 7AA	80% - 90 kg	1231,3,-
DKP 4527 29U 7AB	100% - 65 kg	1450,5,-
DKP 4527 29U 7AC	100% - 180 kg	1738,6,-

Order code	Sliding	Price (€)
DKP 4527 29U 8AA	80% - 90 kg	1308,5,-
DKP 4527 29U 8AB	100% - 65 kg	1558,9,-

Order code	Sliding	Price (€)
DKP 4527 29U 9AA	80% - 90 kg	1385,7,-
DKP 4527 29U 9AB	100% - 65 kg	1667,3,-

Order code	Sliding	Price (€)
DKP 4527 29U 10AA	80% - 90 kg	1462,8,-
DKP 4527 29U 10AB	100% - 65 kg	1775,8,-

Order code	Sliding	Price (€)
DKP 4527 29U 11AA	80% - 90 kg	1540,0,-
DKP 4527 29U 11AB	100% - 65 kg	1884,2,-

Individual programme, accessories dimensional line 5427E

Body for drawers installation

Order code	Height	Carrying capacity (kg)	Price (€)
DKP KZ 5427 17U	840	760	289,7,-
DKP KZ 5427 21U	1018	938	365,4,-
DKP KZ 5427 26U	1240	1160	460,6,-
DKP KZ 5427 29U	1373	1293	514,1,-
	A	B	

Equipment of body intended for installation of drawers:

- The body is furnished with a central locking system (cylindrical lock) with an integrated function which blocks the opening of several drawers together - it's a protection against overturning.
- The bottom part of the body is furnished with slots for anchoring to the floor. We recommend anchoring the cabinet in case it will be loaded to the limit of its maximum carrying capacity.
- Assembly mouldings on the inner part of bodies allow installing drawers in 1U = 44,45 mm raster.
- Into the body there can be mounted a holder of 19" rack accessories, a stopping device, a leading out moulding for cables and hoses and an output slot. You can also install a panel with slots for cables.

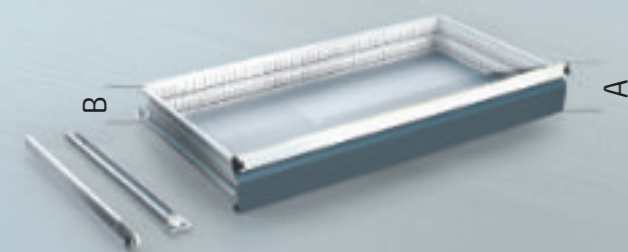
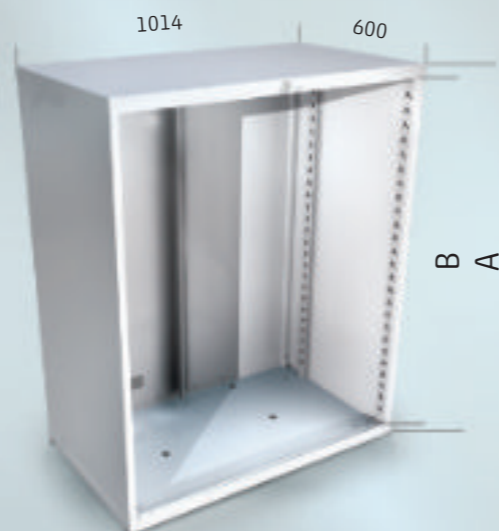

Drawers 5427E, sliding 80%, carrying capacity 90 kg

Order code	Front's height	Side's height	Price (€)
DKP Z 5427 2U A	85	58	101,0,-
DKP Z 5427 3U A	129	102	109,3,-
DKP Z 5427 4U A	174	147	117,8,-
DKP Z 5427 5U A	218	191	126,1,-
DKP Z 5427 6U A	263	236	134,6,-
	A	B	

The drawers are guided in massive slide-rails Fullterer with four ball bearings. These slide-rails are characteristic by an easy and silent running.

The drawers are furnished with a comfort aluminium handle with an installed holder of a safety pin DKP PVZ and with a groove for a label with drawer's contents.

The inner parts of the drawers are pressed and grooved for installing of metal divider sets. Groove spacing is 1E = 17 mm. Useable drawer plan is 910 x 451 mm.

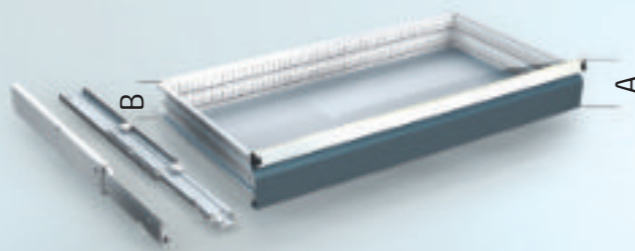
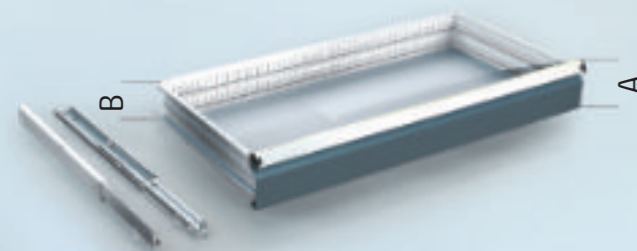

Drawers 5427E, sliding 100%, carrying capacity 65 kg

Order code	Front's height	Side's height	Price (€)
DKP Z 5427 2U B	85	58	132,3,-
DKP Z 5427 3U B	129	102	140,6,-
DKP Z 5427 4U B	174	147	149,1,-
DKP Z 5427 5U B	218	191	157,5,-
DKP Z 5427 6U B	263	236	165,8,-
	A	B	

The drawers are guided in massive slide-rails Fullterer with ten pulleys. These slide-rails are characteristic by an easy and silent running.

The drawers are furnished with a comfort aluminium handle with an installed holder of a safety pin DKP PVZ and with a groove for a label with drawer's contents.

The inner parts of the drawers are pressed and grooved for installing of metal divider sets. Groove spacing is 1E = 17 mm. Useable drawer plan is 910 x 451 mm.

Drawers 5427E, sliding 100%, nosnost 180 kg

Order code	Front's height	Side's height	Price (€)
DKP Z 5427 3U C	129	102	181,8,-
DKP Z 5427 4U C	174	147	190,2,-
DKP Z 5427 5U C	218	191	198,6,-
DKP Z 5427 6U C	263	236	207,0,-
	A	B	

The drawers are guided in massive slide-rails Fullterer with ten pulleys. These slide-rails are characteristic by an easy and silent running.

The drawers are furnished with a comfort aluminium handle with an installed holder of a safety pin DKP PVZ and with a groove for a label with drawer's contents.

The inner parts of the drawers are pressed and grooved for installing of metal divider sets. Groove spacing is 1E = 17 mm. Useable drawer plan is 910 x 451 mm.

Divider sets for drawers

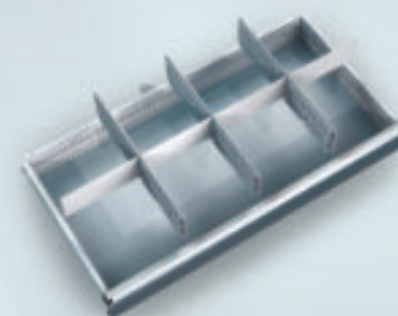

Order code	Price (€)
DMZ 5427 2U 8P	33,5,-
DMZ 5427 3U 8P	48,0,-
DMZ 5427 5U 8P	66,3,-

The divider set of the 54E x 27E drawers allows dividing the drawer's inner part into 8 pieces. It contents 3x perforated dividing bar 27E, 3x bar 14E and 1x bar 12E.

The 3U divider set is intended for drawers 3U and 4U, the 5U divider set is intended for drawers 5U and 6U.

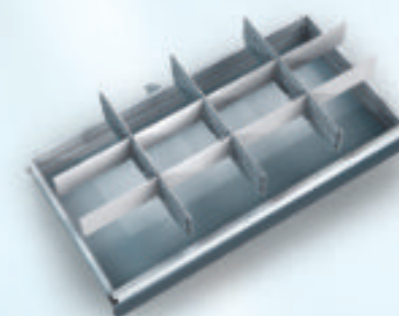

Order code	Price (€)
DMZ 5427 2U 12P	42,2,-
DMZ 5427 3U 12P	61,7,-
DMZ 5427 5U 12P	89,8,-

The divider set of the 54E x 27E drawers allows dividing the drawer's inner part into 12 pieces. It contents 3x perforated dividing bar 27E, 6x bar 14E and 2x bar 12E.

The 3U divider set is intended for drawers 3U and 4U, the 5U divider set is intended for drawers 5U and 6U.

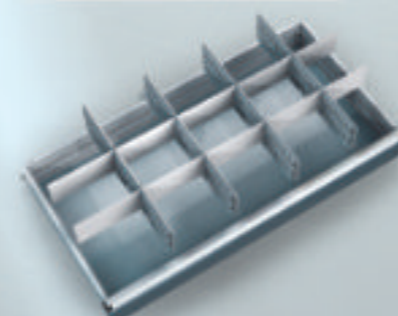

Order code	Price (€)
DMZ 5427 2U 15P	49,4,-
DMZ 5427 3U 15P	71,3,-
DMZ 5427 5U 15P	101,3,-

The divider set of the 54E x 27E drawers allows dividing the drawer's inner part into 15 pieces. It contents 4x perforated dividing bar 27E, 8x bar 12E and 2x bar 6E.

The 3U divider set is intended for drawers 3U and 4U, the 5U divider set is intended for drawers 5U and 6U.



Perforated drawer's bottom

Order code	Price (€)
DKP PDZ 5427	8,3,-

For an extra charge the drawers can be furnished with a perforated bottom. It is useful to combine it with a metal divider set. Bars can be tightly screwed to the drawer's bottom.



Damping

Order code	Price (€)
TSI 80	35,9,-

The drawers of the DKP line cabinets can be furnished for an extra charge with a system of damped closing. This system is intended for drawers with maximum weighting up to 70 kg. A high quality gas damper ensures secure running and a long lifetime of the system.

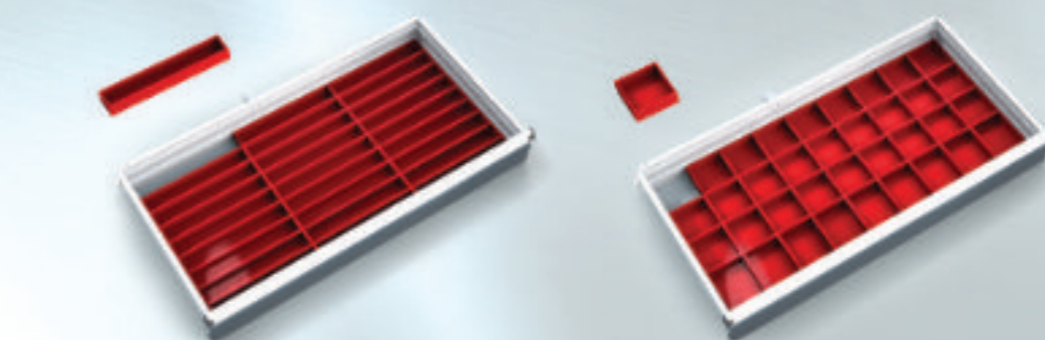

Plastic bins

The plastic bins are intended for dividing the inner drawer's part. On pages 92 and 93 of this catalogue you can find the complete assortment of already configured sets of bins designed directly for particular dimensional lines of drawers. In case that any of those sets do not suit you it is possible to create an individual set. Components for creating the set you will find on page 88.



Upper putting surface

Order code	Price (€)
DKP HPR 5427	43,7,-

For an extra charge the body can be furnished with a putting surface with 5 mm width foam filling and with a 20 mm high frame. This frame is a protection against falling of small objects.



Pallet base

Order code	Price (€)
DKP PMP 5427	109,0,-

The pallet base makes the cabinet's manipulation easier.



PE foam filling of 5,0 mm height

Order code	Price (€)
DKP PVZ 5427	15,9,-

The foam filling is an efficient protection of gauges and other sensitive devices against their damage.



Individual foam filling of drawer

We are able to produce customized foam fillings according to customer's requirement and given electronic drawings. Minimum order number is 20 pcs.

Standard programme dimensional line 5427E

Drawer cabinets 17U

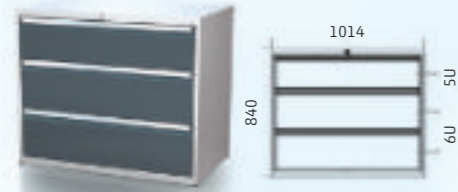

Order code	Sliding	Price (€)
DKP 5427 17U 3AA	80% - 90 kg	685,1,-
DKP 5427 17U 3AB	100% - 65 kg	778,9,-
DKP 5427 17U 3AC	100% - 180 kg	902,4,-

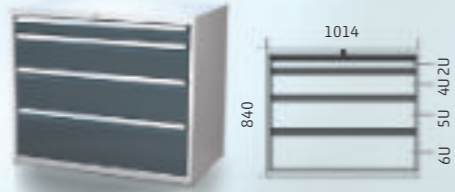

Order code	Sliding	Price (€)
DKP 5427 17U 4AA	80% - 90 kg	769,1,-
DKP 5427 17U 4AB	100% - 65 kg	894,3,-

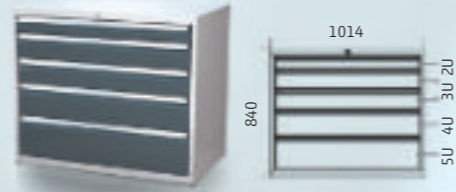

Order code	Sliding	Price (€)
DKP 5427 17U 5AA	80% - 90 kg	853,2,-
DKP 5427 17U 5AB	100% - 65 kg	1009,7,-

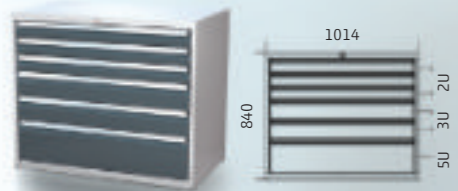

Order code	Sliding	Price (€)
DKP 5427 17U 6AA	80% - 90 kg	937,4,-
DKP 5427 17U 6AB	100% - 65 kg	1125,2,-

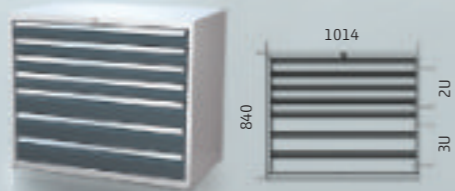

Order code	Sliding	Price (€)
DKP 5427 17U 7AA	80% - 90 kg	1021,5,-
DKP 5427 17U 7AB	100% - 65 kg	1240,6,-

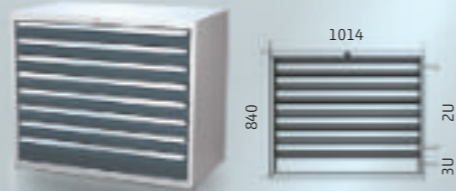

Order code	Sliding	Price (€)
DKP 5427 17U 8AA	80% - 90 kg	1105,6,-
DKP 5427 17U 8AB	100% - 65 kg	1355,9,-

Drawer cabinets 21U

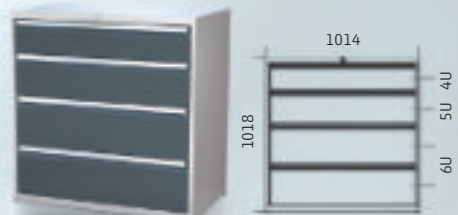

Order code	Sliding	Price (€)
DKP 5427 21U 4AA	80% - 90 kg	878,5,-
DKP 5427 21U 4AB	100% - 65 kg	1003,7,-
DKP 5427 21U 4AC	100% - 180 kg	1168,3,-

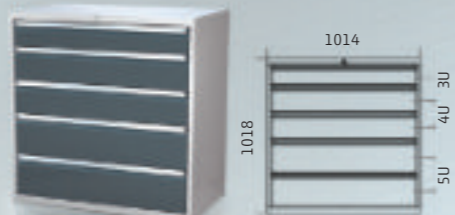

Order code	Sliding	Price (€)
DKP 5427 21U 5AA	80% - 90 kg	962,6,-
DKP 5427 21U 5AB	100% - 65 kg	1119,1,-
DKP 5427 21U 5AC	100% - 180 kg	1324,9,-

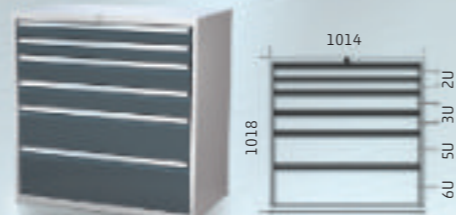

Order code	Sliding	Price (€)
DKP 5427 21U 6AA	80% - 90 kg	1046,7,-
DKP 5427 21U 6AB	100% - 65 kg	1234,5,-

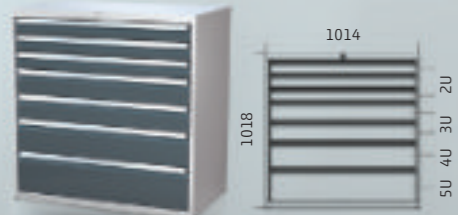

Order code	Sliding	Price (€)
DKP 5427 21U 7AA	80% - 90 kg	1130,8,-
DKP 5427 21U 7AB	100% - 65 kg	1349,9,-

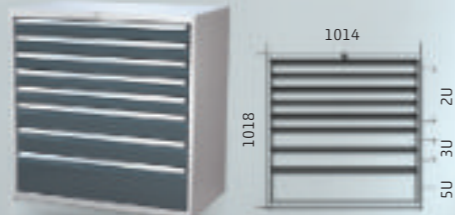

Order code	Sliding	Price (€)
DKP 5427 21U 8AA	80% - 90 kg	1214,9,-
DKP 5427 21U 8AB	100% - 65 kg	1465,3,-

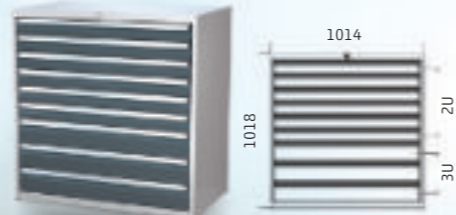

Order code	Sliding	Price (€)
DKP 5427 21U 9AA	80% - 90 kg	1299,0,-
DKP 5427 21U 9AB	100% - 65 kg	1580,6,-

Drawer cabinets 26U

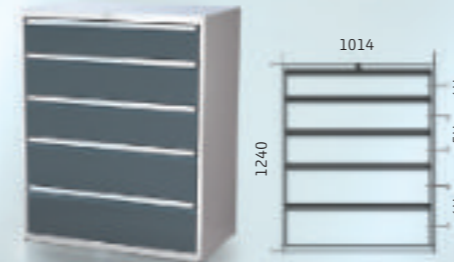

Order code	Sliding	Price (€)
DKP 5427 26U 5AA	80% - 90 kg	1099,8,-
DKP 5427 26U 5AB	100% - 65 kg	1256,3,-
DKP 5427 26U 5AC	100% - 180 kg	1462,1,-

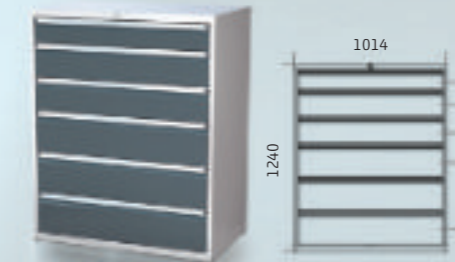

Order code	Sliding	Price (€)
DKP 5427 26U 6AA	80% - 90 kg	1183,9,-
DKP 5427 26U 6AB	100% - 65 kg	1371,7,-
DKP 5427 26U 6AC	100% - 180 kg	1618,6,-

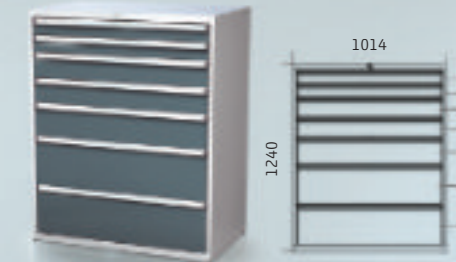

Order code	Sliding	Price (€)
DKP 5427 26U 7AA	80% - 90 kg	1268,0,-
DKP 5427 26U 7AB	100% - 65 kg	1487,1,-

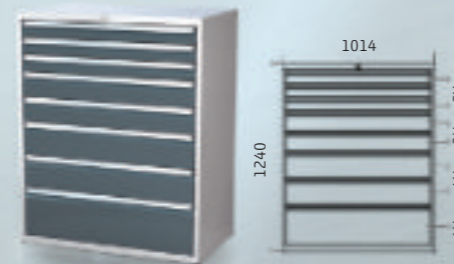

Order code	Sliding	Price (€)
DKP 5427 26U 8AA	80% - 90 kg	1352,1,-
DKP 5427 26U 8AB	100% - 65 kg	1602,5,-

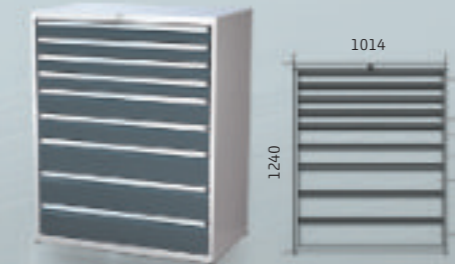

Order code	Sliding	Price (€)
DKP 5427 26U 9AA	80% - 90 kg	1436,2,-
DKP 5427 26U 9AB	100% - 65 kg	1717,9,-

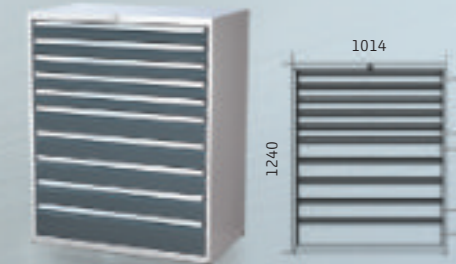

Order code	Sliding	Price (€)
DKP 5427 26U 10AA	80% - 90 kg	1520,3,-
DKP 5427 26U 10AB	100% - 65 kg	1833,3,-

Drawer cabinets 29U

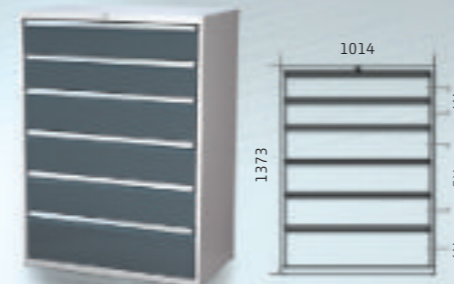

Order code	Sliding	Price (€)
DKP 5427 29U 6AA	80% - 90 kg	1262,7,-
DKP 5427 29U 6AB	100% - 65 kg	1450,5,-
DKP 5427 29U 6AC	100% - 180 kg	1697,5,-

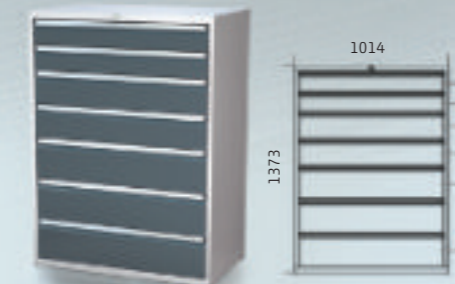

Order code	Sliding	Price (€)
DKP 5427 29U 7AA	80% - 90 kg	1346,8,-
DKP 5427 29U 7AB	100% - 65 kg	1565,9,-
DKP 5427 29U 7AC	100% - 180 kg	1854,0,-

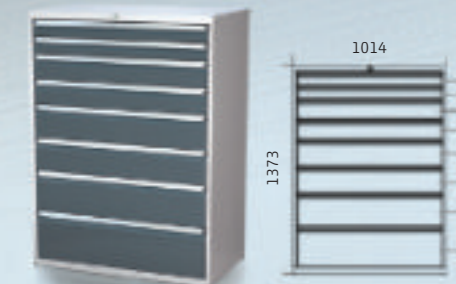

Order code	Sliding	Price (€)
DKP 5427 29U 8AA	80% - 90 kg	1430,9,-
DKP 5427 29U 8AB	100% - 65 kg	1681,3,-

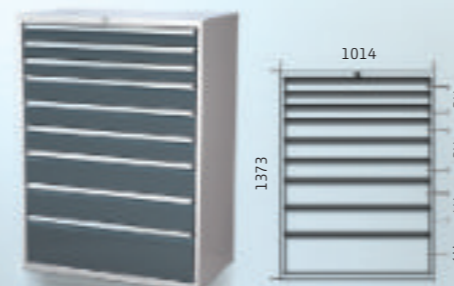

Order code	Sliding	Price (€)
DKP 5427 29U 9AA	80% - 90 kg	1515,1,-
DKP 5427 29U 9AB	100% - 65 kg	1796,8,-

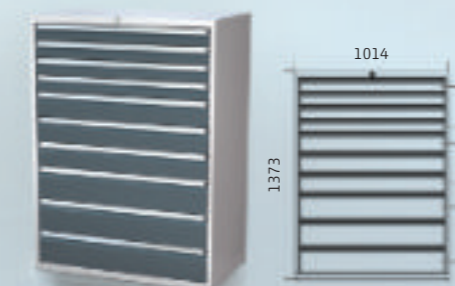

Order code	Sliding	Price (€)
DKP 5427 29U 10AA	80% - 90 kg	1599,2,-
DKP 5427 29U 10AB	100% - 65 kg	1912,1,-

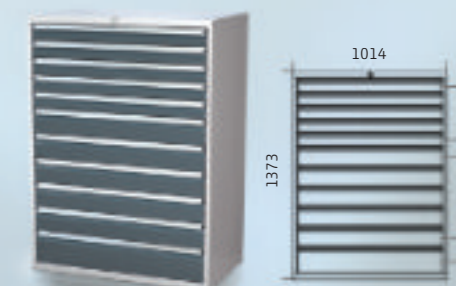

Order code	Sliding	Price (€)
DKP 5427 29U 11AA	80% - 90 kg	1683,3,-
DKP 5427 29U 11AB	100% - 65 kg	2027,5,-

Individual programme, accessories dimensional line 3636E

Body for drawers installation

Order code	Height	Carrying capacity (kg)	Price (€)
DKP KZ 3636 17U	840	720	268,2,-
DKP KZ 3636 21U	1018	720	338,3,-
DKP KZ 3636 26U	1240	720	426,5,-
DKP KZ 3636 29U	1373	720	476,0,-

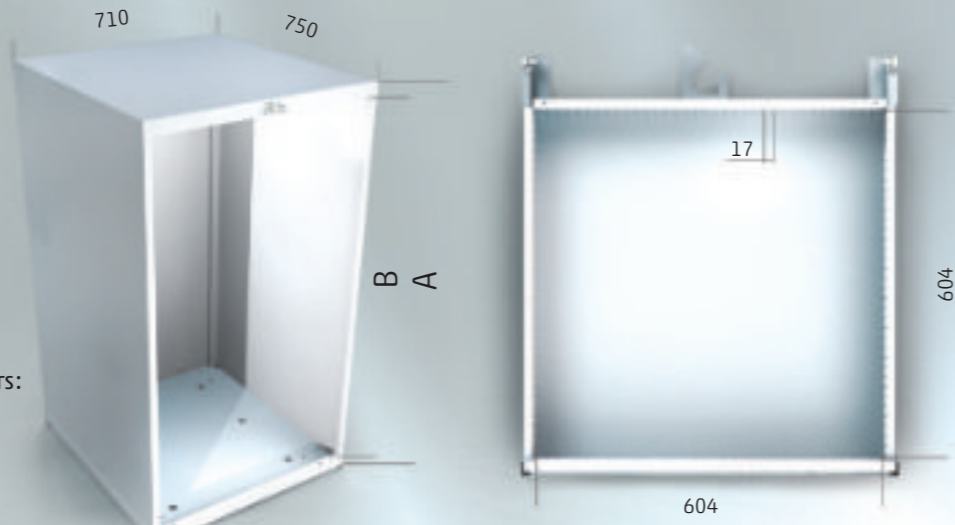

Equipment of body intended for installation of drawers:

- The body is furnished with a central locking system (cylindrical lock) with an integrated function which blocks the opening of several drawers together - it's a protection against overturning.
- The bottom part of the body is furnished with slots for anchoring to the floor. We recommend anchoring the cabinet in case it will be loaded to the limit of its maximum carrying capacity.
- Assembly mouldings on the inner part of bodies allow installing drawers in 1U = 44,45 mm raster.
- Into the body there can be mounted a holder of 19" rack accessories, a stopping device, a leading out moulding for cables and hoses and an output slot. You can also install a panel with slots for cables.

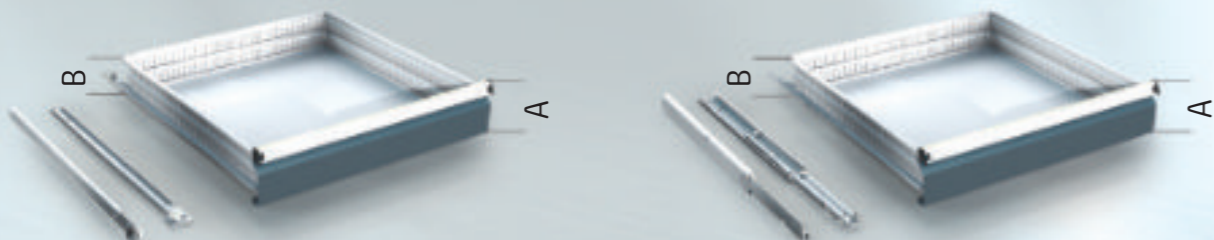

Drawers 3636E, sliding 80%, carrying capacity 90 kg

Order code	Front's height	Side's height	Price (€)
DKP Z 3636 2U A	85	58	94,3,-
DKP Z 3636 3U A	129	102	102,2,-
DKP Z 3636 4U A	174	147	110,1,-
DKP Z 3636 5U A	218	191	117,9,-
DKP Z 3636 6U A	263	236	125,8,-

The drawers are guided in massive slide-rails Fullterer with four ball bearings. These slide-rails are characteristic by an easy and silent running.

The drawers are furnished with a comfort aluminium handle with an installed holder of a safety pin DKP PVZ and with a groove for a label with drawer's contents.

The inner parts of the drawers are pressed and grooved for installing of metal divider sets. Groove spacing is 1E = 17 mm. Useable drawer plan is 604 x 604 mm.

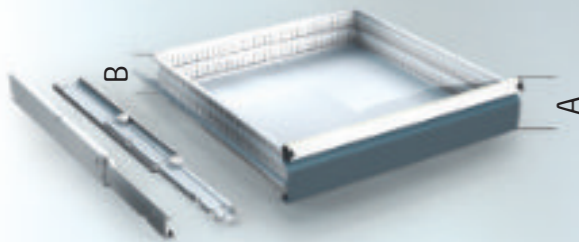

Drawers 3636E, sliding 100%, carrying capacity 180 kg

Order code	Front's height	Side's height	Price (€)
DKP Z 3636 3U C	129	102	183,2,-
DKP Z 3636 4U C	174	147	191,1,-
DKP Z 3636 5U C	218	191	198,9,-
DKP Z 3636 6U C	263	236	206,8,-

The drawers are guided in massive slide-rails Fullterer with ten pulleys. These slide-rails are characteristic by an easy and silent running.

The drawers are furnished with a comfort aluminium handle with an installed holder of a safety pin DKP PVZ and with a groove for a label with drawer's contents.

The inner parts of the drawers are pressed and grooved for installing of metal divider sets. Groove spacing is 1E = 17 mm. Useable drawer plan is 604 x 604 mm.

Drawers 3636E, sliding 100%, carrying capacity 65 kg

Order code	Front's height	Side's height	Price (€)
DKP Z 3636 2U B	85	58	129,0,-
DKP Z 3636 3U B	129	102	136,9,-
DKP Z 3636 4U B	174	147	144,8,-
DKP Z 3636 5U B	218	191	152,6,-
DKP Z 3636 6U B	263	236	160,5,-

The drawers are guided in massive slide-rails Fullterer with ten pulleys. These slide-rails are characteristic by an easy and silent running.

The drawers are furnished with a comfort aluminium handle with an installed holder of a safety pin DKP PVZ and with a groove for a label with drawer's contents.

The inner parts of the drawers are pressed and grooved for installing of metal divider sets. Groove spacing is 1E = 17 mm. Useable drawer plan is 604 x 604 mm.

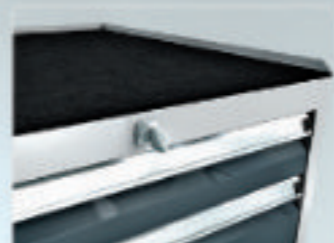

Upper putting surface

Order code	Price (€)
DKP HPR 3636	40,4,-

For an extra charge the body can be furnished with a putting surface with 5 mm width foam filling and with a 20 mm high frame. This frame is a protection against falling of small objects.



Pallet base

Order code	Price (€)
DKP PMP 3636	101,0,-

The pallet base makes the cabinet's manipulation easier.

Divider sets for drawers

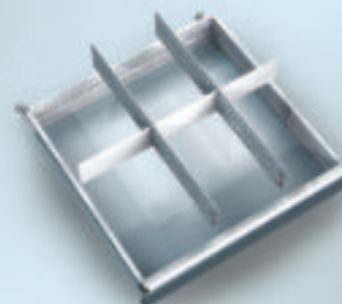

Order code	Price (€)
DMZ 3636 2U 6P	27,3,-
DMZ 3636 3U 6P	38,8,-
DMZ 3636 5U 6P	52,4,-

The divider set of the 36E x 36E drawers allows dividing the drawer's inner part into 6 pieces. It contents 2x perforated dividing bar 36E and 3x bar 12E.

The 3U divider set is intended for drawers 3U and 4U, the 5U divider set is intended for drawers 5U and 6U.

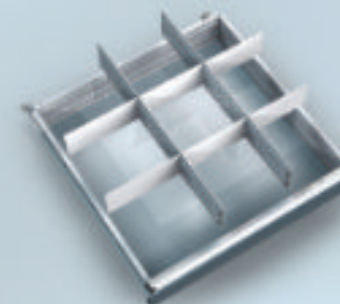

Order code	Price (€)
DMZ 3636 2U 9P	32,8,-
DMZ 3636 3U 9P	47,3,-
DMZ 3636 5U 9P	67,1,-

The divider set of the 36E x 36E drawers allows dividing the drawer's inner part into 9 pieces. It contents 2x perforated dividing bar 36E and 6x bar 12E.

The 3U divider set is intended for drawers 3U and 4U, the 5U divider set is intended for drawers 5U and 6U.

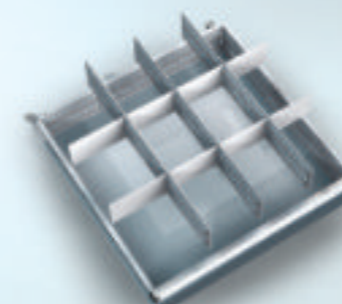

Order code	Price (€)
DMZ 3636 2U 12P	43,6,-
DMZ 3636 3U 12P	62,7,-
DMZ 3636 5U 12P	86,5,-

The divider set of the 36E x 36E drawers allows dividing the drawer's inner part into 12 pieces. It contents 3x perforated dividing bar 36E and 8x bar 9E.

The 3U divider set is intended for drawers 3U and 4U, the 5U divider set is intended for drawers 5U and 6U.



Damping

Order code	Price (€)
TSI 80	35,9,-

The drawers of the DKP line cabinets can be furnished for an extra charge with a system of damped closing. This system is intended for drawers with maximum weighting up to 70 kg. A high quality gas damper ensures secure running and a long lifetime of the system.

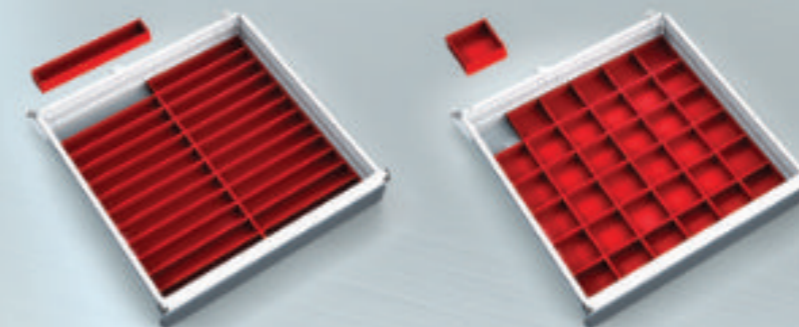

Plastic bins

The plastic bins are intended for dividing the inner drawer's part. On pages 92 and 93 of this catalogue you can find the complete assortment of already configured sets of bins designed directly for particular dimensional lines of drawers. In case that any of those sets do not suit you it is possible to create an individual set. Components for creating the set you will find on page 88.



Perforated drawer's bottom

Order code	Price (€)
DKP PDZ 3636	7,7,-

For an extra charge the drawers can be furnished with a perforated bottom. It is useful to combine it with a metal divider set. Bars can be tightly screwed to the drawer's bottom.



PE foam filling of 5,0 mm height

Order code	Price (€)
DKP PVZ 3636	19,8,-

The foam filling is an efficient protection of gauges and other sensitive devices against their damage.

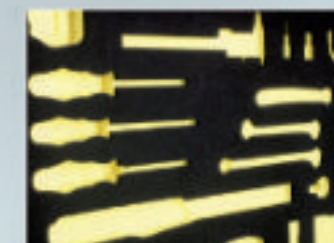

Individual foam filling of drawer

We are able to produce customized foam fillings according to customer's requirement and given electronic drawings. Minimum order number is 20 pcs.

Standard programme dimensional line 3636E

Drawer cabinets 17U

Order code	Sliding	Price (€)
DKP 3636 17U 3AA	80% - 90 kg	637,7,-
DKP 3636 17U 3AB	100% - 65 kg	741,8,-
DKP 3636 17U 3AC	100% - 180 kg	880,6,-

Order code	Sliding	Price (€)
DKP 3636 17U 4AA	80% - 90 kg	716,3,-
DKP 3636 17U 4AB	100% - 65 kg	855,2,-

Order code	Sliding	Price (€)
DKP 3636 17U 5AA	80% - 90 kg	794,9,-
DKP 3636 17U 5AB	100% - 65 kg	968,4,-

Order code	Sliding	Price (€)
DKP 3636 17U 6AA	80% - 90 kg	873,5,-
DKP 3636 17U 6AB	100% - 65 kg	1081,7,-

Order code	Sliding	Price (€)
DKP 3636 17U 7AA	80% - 90 kg	952,2,-
DKP 3636 17U 7AB	100% - 65 kg	1195,0,-

Order code	Sliding	Price (€)
DKP 3636 17U 8AA	80% - 90 kg	1030,8,-
DKP 3636 17U 8AB	100% - 65 kg	1308,3,-

Drawer cabinets 21U

Order code	Sliding	Price (€)
DKP 3636 21U 4AA	80% - 90 kg	817,8,-
DKP 3636 21U 4AB	100% - 65 kg	956,6,-
DKP 3636 21U 4AC	100% - 180 kg	1141,7,-

Order code	Sliding	Price (€)
DKP 3636 21U 5AA	80% - 90 kg	896,4,-
DKP 3636 21U 5AB	100% - 65 kg	1069,9,-
DKP 3636 21U 5AC	100% - 180 kg	1301,3,-

Order code	Sliding	Price (€)
DKP 3636 21U 6AA	80% - 90 kg	975,1,-
DKP 3636 21U 6AB	100% - 65 kg	1183,2,-

Order code	Sliding	Price (€)
DKP 3636 21U 7AA	80% - 90 kg	1053,6,-
DKP 3636 21U 7AB	100% - 65 kg	1296,5,-

Order code	Sliding	Price (€)
DKP 3636 21U 8AA	80% - 90 kg	1132,3,-
DKP 3636 21U 8AB	100% - 65 kg	1409,8,-

Order code	Sliding	Price (€)
DKP 3636 21U 9AA	80% - 90 kg	1210,9,-
DKP 3636 21U 9AB	100% - 65 kg	1523,2,-

Drawer cabinets 26U

Order code	Sliding	Price (€)
DKP 3636 26U 5AA	80% - 90 kg	1023,9,-
DKP 3636 26U 5AB	100% - 65 kg	1197,4,-
DKP 3636 26U 5AC	100% - 180 kg	1428,6,-

Order code	Sliding	Price (€)
DKP 3636 26U 6AA	80% - 90 kg	1102,4,-
DKP 3636 26U 6AB	100% - 65 kg	1310,6,-
DKP 3636 26U 6AC	100% - 180 kg	1588,2,-

Order code	Sliding	Price (€)
DKP 3636 26U 7AA	80% - 90 kg	1181,0,-
DKP 3636 26U 7AB	100% - 65 kg	1423,9,-

Order code	Sliding	Price (€)
DKP 3636 26U 8AA	80% - 90 kg	1259,7,-
DKP 3636 26U 8AB	100% - 65 kg	1537,3,-

Order code	Sliding	Price (€)
DKP 3636 26U 9AA	80% - 90 kg	1338,2,-
DKP 3636 26U 9AB	100% - 65 kg	1650,5,-

Order code	Sliding	Price (€)
DKP 3636 26U 10AA	80% - 90 kg	1416,9,-
DKP 3636 26U 10AB	100% - 65 kg	1763,9,-

Drawer cabinets 29U

Order code	Sliding	Price (€)
DKP 3636 29U 6AA	80% - 90 kg	1175,6,-
DKP 3636 29U 6AB	100% - 65 kg	1383,8,-
DKP 3636 29U 6AC	100% - 180 kg	1661,4,-

Order code	Sliding	Price (€)
DKP 3636 29U 7AA	80% - 90 kg	1254,3,-
DKP 3636 29U 7AB	100% - 65 kg	1497,2,-
DKP 3636 29U 7AC	100% - 180 kg	1821,0,-

Order code	Sliding	Price (€)
DKP 3636 29U 8AA	80% - 90 kg	1332,9,-
DKP 3636 29U 8AB	100% - 65 kg	1610,5,-

Order code	Sliding	Price (€)
DKP 3636 29U 9AA	80% - 90 kg	1411,5,-
DKP 3636 29U 9AB	100% - 65 kg	1723,8,-

Order code	Sliding	Price (€)
DKP 3636 29U 10AA	80% - 90 kg	1490,1,-
DKP 3636 29U 10AB	100% - 65 kg	1837,1,-

Order code	Sliding	Price (€)
DKP 3636 29U 11AA	80% - 90 kg	1568,7,-
DKP 3636 29U 11AB	100% - 65 kg	1950,4,-

Individual programme, accessories dimensional line 4536E

Body for drawers installation

Order code	Height	Carrying capacity (kg)	Price (€)
DKP KZ 4536 17U	840	760	302,9,-
DKP KZ 4536 21U	1018	938	382,0,-
DKP KZ 4536 26U	1240	1160	481,5,-
DKP KZ 4536 29U	1373	1293	537,5,-
	A	B	

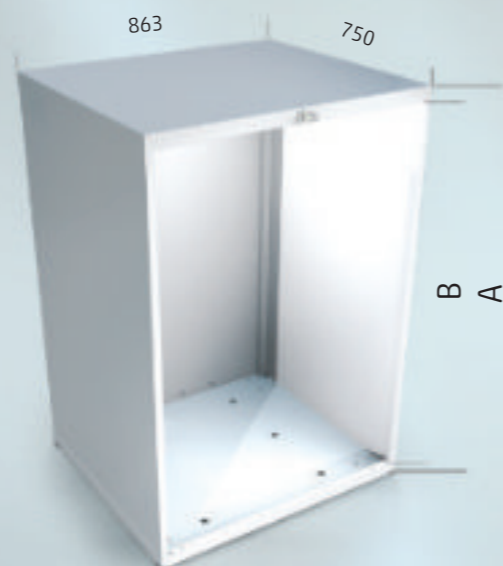

Equipment of body intended for installation of drawers:

- The body is furnished with a central locking system (cylindrical lock) with an integrated function which blocks the opening of several drawers together - it's a protection against overturning.
- The bottom part of the body is furnished with slots for anchoring to the floor. We recommend anchoring the cabinet in case it will be loaded to the limit of its maximum carrying capacity.
- Assembly mouldings on the inner part of bodies allow installing drawers in 1U = 44,45 mm raster.
- Into the body there can be mounted a holder of 19" rack accessories, a stopping device, a leading out moulding for cables and hoses and an output slot. You can also install a panel with slots for cables.

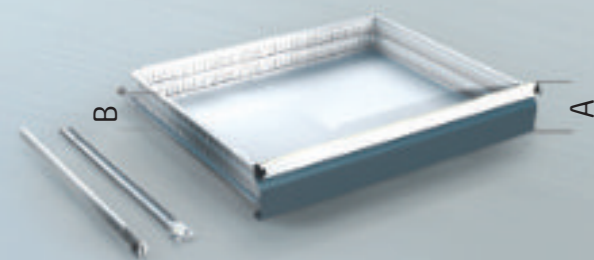

Drawers 4536E, sliding 80%, carrying capacity 90 kg

Order code	Front's height	Side's height	Price (€)
DKP Z 4536 2U A	85	58	103,7,-
DKP Z 4536 3U A	129	102	112,3,-
DKP Z 4536 4U A	174	147	121,0,-
DKP Z 4536 5U A	218	191	129,6,-
DKP Z 4536 6U A	263	236	138,2,-
	A	B	



The drawers are guided in massive slide-rails Fullterer with four ball bearings. These slide-rails are characteristic by an easy and silent running.

The drawers are furnished with a comfort aluminium handle with an installed holder of a safety pin DKP PVZ and with a groove for a label with drawer's contents.

The inner parts of the drawers are pressed and grooved for installing of metal divider sets. Groove spacing is 1E = 17 mm. Useable drawer plan is 757 x 604 mm.

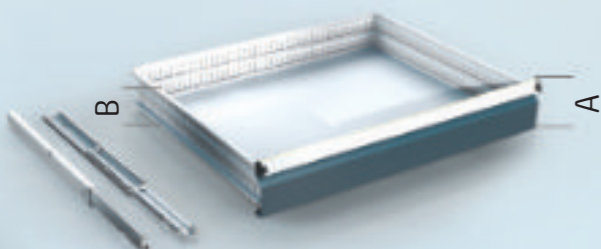

Drawers 4536E, sliding 100%, carrying capacity 65 kg

Order code	Front's height	Side's height	Price (€)
DKP Z 4536 2U B	85	58	138,4,-
DKP Z 4536 3U B	129	102	147,0,-
DKP Z 4536 4U B	174	147	155,7,-
DKP Z 4536 5U B	218	191	164,3,-
DKP Z 4536 6U B	263	236	173,0,-
	A	B	

The drawers are guided in massive slide-rails Fullterer with ten pulleys. These slide-rails are characteristic by an easy and silent running.

The drawers are furnished with a comfort aluminium handle with an installed holder of a safety pin DKP PVZ and with a groove for a label with drawer's contents.

The inner parts of the drawers are pressed and grooved for installing of metal divider sets. Groove spacing is 1E = 17 mm. Useable drawer plan is 757 x 604 mm.

Drawers 4536E, sliding 100%, carrying capacity 180 kg

Order code	Front's height	Side's height	Price (€)
DKP Z 4536 3U C	129	102	193,3,-
DKP Z 4536 4U C	174	147	201,9,-
DKP Z 4536 5U C	218	191	210,6,-
DKP Z 4536 6U C	263	236	219,2,-
	A	B	

The drawers are guided in massive slide-rails Fullterer with ten pulleys. These slide-rails are characteristic by an easy and silent running.

The drawers are furnished with a comfort aluminium handle with an installed holder of a safety pin DKP PVZ and with a groove for a label with drawer's contents.

The inner parts of the drawers are pressed and grooved for installing of metal divider sets. Groove spacing is 1E = 17 mm. Useable drawer plan is 757 x 604 mm.

Divider sets for drawers

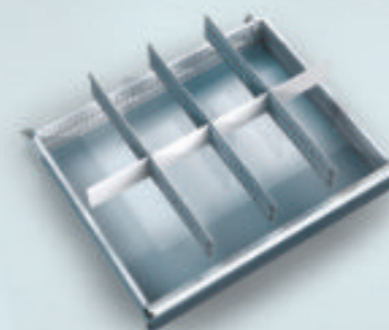

Order code	Price (€)
DMZ 4536 2U 8P	39,5,-
DMZ 4536 3U 8P	56,1,-
DMZ 4536 5U 8P	75,0,-

The divider set of the 45E x 36E drawers allows dividing the drawer's inner part into 8 pieces. It contains 3x perforated dividing bar 36E, 3x bar 12E and 1x bar 9E.

The 3U divider set is intended for drawers 3U and 4U, the 5U divider set is intended for drawers 5U and 6U.

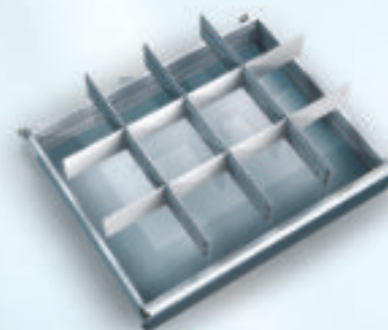

Order code	Price (€)
DMZ 4536 2U 12P	46,4,-
DMZ 4536 3U 12P	66,8,-
DMZ 4536 5U 12P	93,4,-

The divider set of the 45E x 36E drawers allows dividing the drawer's inner part into 12 pieces. It contains 3x perforated dividing bar 36E, 6x bar 12E and 2x bar 9E.

The 3U divider set is intended for drawers 3U and 4U, the 5U divider set is intended for drawers 5U and 6U.

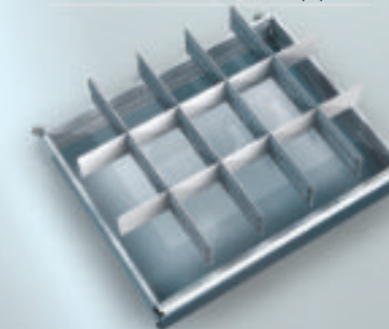

Order code	Price (€)
DMZ 4536 2U 15P	57,2,-
DMZ 4536 3U 15P	82,2,-
DMZ 4536 5U 15P	112,8,-

The divider set of the 45E x 36E drawers allows dividing the drawer's inner part into 15 pieces. It contains 4x perforated dividing bar 36E and 10x bar 9E.

The 3U divider set is intended for drawers 3U and 4U, the 5U divider set is intended for drawers 5U and 6U.



Perforated drawer's bottom

Order code	Price (€)
DKP PDZ 4536	8,6,-

For an extra charge the drawers can be furnished with a perforated bottom. It is useful to combine it with a metal divider set. Bars can be tightly screwed to the drawer's bottom.



Damping

Order code	Price (€)
TSI 80	35,9,-

The drawers of the DKP line cabinets can be furnished for an extra charge with a system of damped closing. This system is intended for drawers with maximum weighting up to 70 kg. A high quality gas damper ensures secure running and a long lifetime of the system.

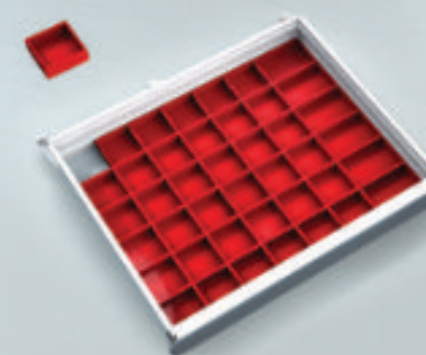
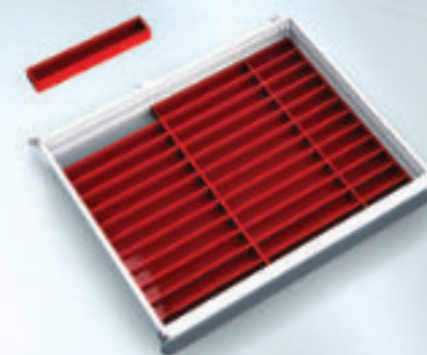

Plastic bins

The plastic bins are intended for dividing the inner drawer's part. On pages 92 and 93 of this catalogue you can find the complete assortment of already configured sets of bins designed directly for particular dimensional lines of drawers. In case that any of those sets do not suit you it is possible to create an individual set. Components for creating the set you will find on page 88.

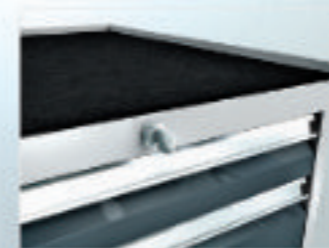

Upper putting surface

Order code	Price (€)
DKP HPR 4536	45,7,-

For an extra charge the body can be furnished with a putting surface with 5 mm width foam filling and with a 20 mm high frame. This frame is a protection against falling of small objects.



Pallet base

Order code	Price (€)
DKP PMP 4536	114,0,-

The pallet base makes the cabinet's manipulation easier.



PE foam filling of 5,0 mm height

Order code	Price (€)
DKP PVZ 4536	20,6,-

The foam filling is an efficient protection of gauges and other sensitive devices against their damage.

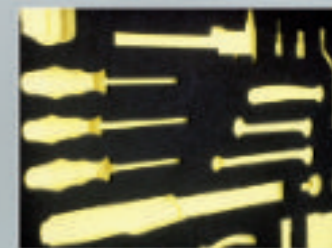

Individual foam filling of drawer

We are able to produce customized foam fillings according to customer's requirement and given electronic drawings. Minimum order number is 20 pcs.

Standard programme dimensional line 4536E

Drawer cabinets 17U

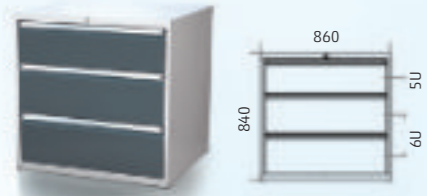

Order code	Sliding	Price (€)
DKP 4536 17U 3AA	80% - 90 kg	709,1,-
DKP 4536 17U 3AB	100% - 65 kg	813,2,-
DKP 4536 17U 3AC	100% - 180 kg	952,0,-



Order code	Sliding	Price (€)
DKP 4536 17U 4AA	80% - 90 kg	795,5,-
DKP 4536 17U 4AB	100% - 65 kg	934,3,-

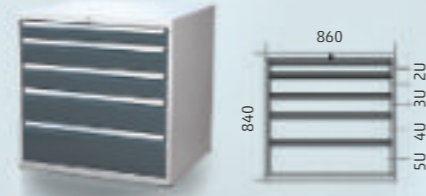

Order code	Sliding	Price (€)
DKP 4536 17U 5AA	80% - 90 kg	881,9,-
DKP 4536 17U 5AB	100% - 65 kg	1055,4,-

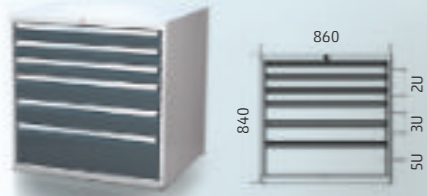

Order code	Sliding	Price (€)
DKP 4536 17U 6AA	80% - 90 kg	968,3,-
DKP 4536 17U 6AB	100% - 65 kg	1176,5,-

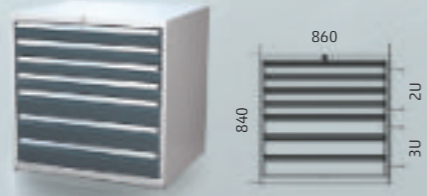

Order code	Sliding	Price (€)
DKP 4536 17U 7AA	80% - 90 kg	1054,8,-
DKP 4536 17U 7AB	100% - 65 kg	1297,7,-

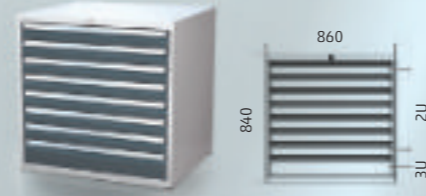

Order code	Sliding	Price (€)
DKP 4536 17U 8AA	80% - 90 kg	1141,2,-
DKP 4536 17U 8AB	100% - 65 kg	1418,8,-

Drawer cabinets 21U

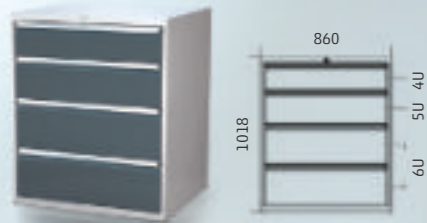

Order code	Sliding	Price (€)
DKP 4536 21U 4AA	80% - 90 kg	909,2,-
DKP 4536 21U 4AB	100% - 65 kg	1048,0,-
DKP 4536 21U 4AC	100% - 180 kg	1233,1,-

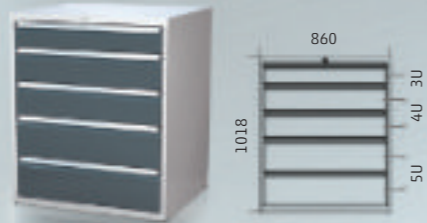

Order code	Sliding	Price (€)
DKP 4536 21U 5AA	80% - 90 kg	995,6,-
DKP 4536 21U 5AB	100% - 65 kg	1169,1,-
DKP 4536 21U 5AC	100% - 180 kg	1400,4,-

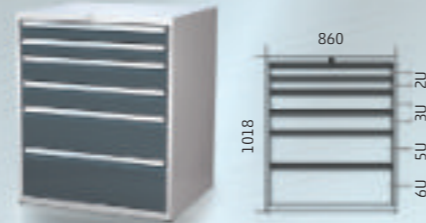

Order code	Sliding	Price (€)
DKP 4536 21U 6AA	80% - 90 kg	1082,0,-
DKP 4536 21U 6AB	100% - 65 kg	1290,2,-

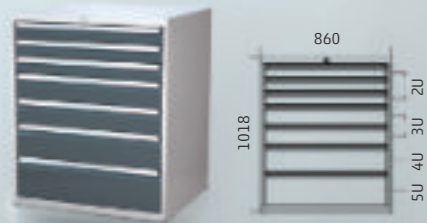

Order code	Sliding	Price (€)
DKP 4536 21U 7AA	80% - 90 kg	1168,5,-
DKP 4536 21U 7AB	100% - 65 kg	1411,4,-

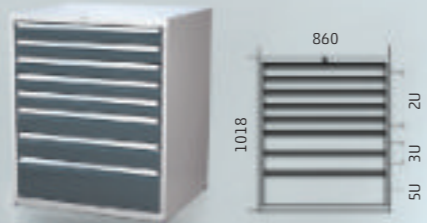

Order code	Sliding	Price (€)
DKP 4536 21U 8AA	80% - 90 kg	1254,9,-
DKP 4536 21U 8AB	100% - 65 kg	1532,5,-

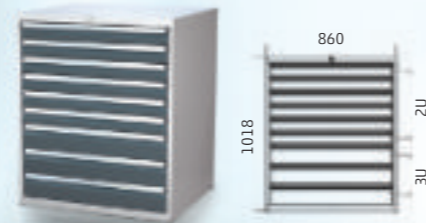

Order code	Sliding	Price (€)
DKP 4536 21U 9AA	80% - 90 kg	1341,3,-
DKP 4536 21U 9AB	100% - 65 kg	1653,6,-

Drawer cabinets 26U

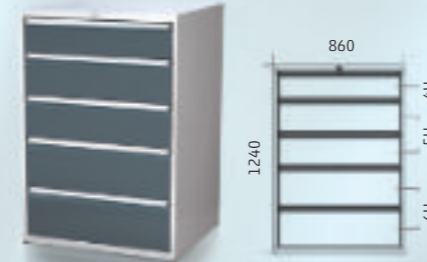

Order code	Sliding	Price (€)
DKP 4536 26U 5AA	80% - 90 kg	1138,3,-
DKP 4536 26U 5AB	100% - 65 kg	1311,8,-
DKP 4536 26U 5AC	100% - 180 kg	1543,1,-

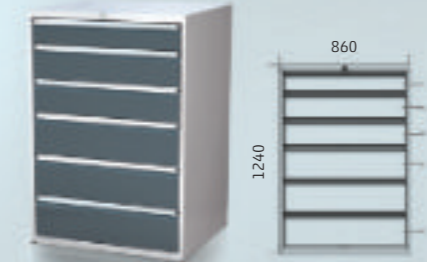

Order code	Sliding	Price (€)
DKP 4536 26U 6AA	80% - 90 kg	1224,7,-
DKP 4536 26U 6AB	100% - 65 kg	1432,9,-
DKP 4536 26U 6AC	100% - 180 kg	1710,5,-

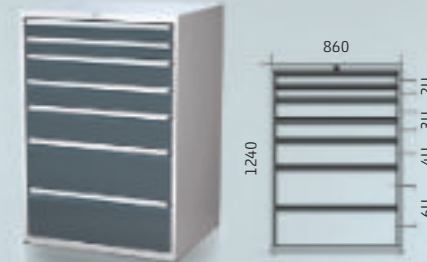

Order code	Sliding	Price (€)
DKP 4536 26U 7AA	80% - 90 kg	1311,2,-
DKP 4536 26U 7AB	100% - 65 kg	1554,0,-

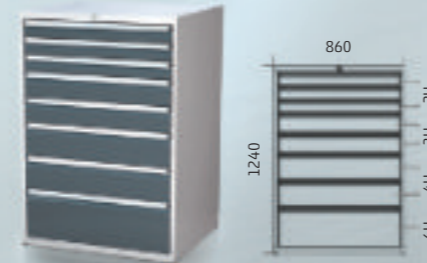

Order code	Sliding	Price (€)
DKP 4536 26U 8AA	80% - 90 kg	1397,6,-
DKP 4536 26U 8AB	100% - 65 kg	1675,1,-

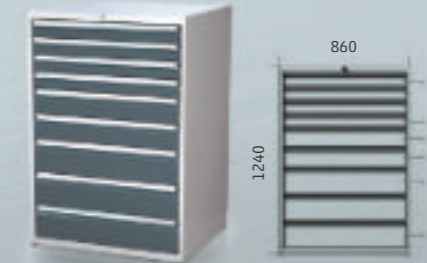

Order code	Sliding	Price (€)
DKP 4536 26U 9AA	80% - 90 kg	1484,0,-
DKP 4536 26U 9AB	100% - 65 kg	1796,3,-

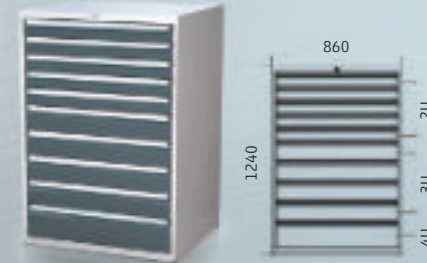

Order code	Sliding	Price (€)
DKP 4527 26U 10AA	80% - 90 kg	1570,4,-
DKP 4527 26U 10AB	100% - 65 kg	1917,4,-

Drawer cabinets 29U



Order code	Sliding	Price (€)
DKP 4536 29U 6AA	80% - 90 kg	1306,7,-
DKP 4536 29U 6AB	100% - 65 kg	1514,9,-
DKP 4536 29U 6AC	100% - 180 kg	1792,4,-



Order code	Sliding	Price (€)
DKP 4536 29U 7AA	80% - 90 kg	1393,2,-
DKP 4536 29U 7AB	100% - 65 kg	1636,1,-
DKP 4536 29U 7AC	100% - 180 kg	1959,9,-



Order code	Sliding	Price (€)
DKP 4536 29U 8AA	80% - 90 kg	1479,6,-
DKP 4536 29U 8AB	100% - 65 kg	1757,2,-

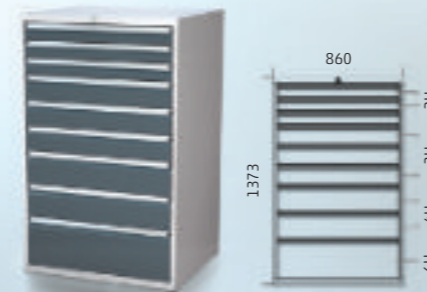

Order code	Sliding	Price (€)
DKP 4536 29U 9AA	80% - 90 kg	1566,0,-
DKP 4536 29U 9AB	100% - 65 kg	1878,2,-

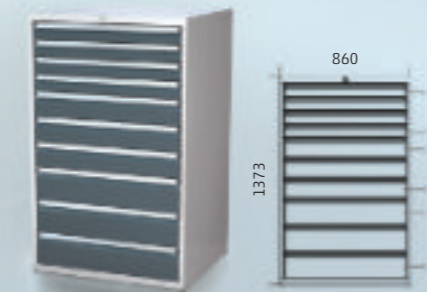

Order code	Sliding	Price (€)
DKP 4536 29U 10AA	80% - 90 kg	1652,4,-
DKP 4536 29U 10AB	100% - 65 kg	1999,3,-



Order code	Sliding	Price (€)
DKP 4536 29U 11AA	80% - 90 kg	1738,8,-
DKP 4536 29U 11AB	100% - 65 kg	2120,5,-

Individual programme, accessories dimensional line 5436E

Body for drawers installation

Order code	Height	Carrying capacity (kg)	Price (€)
DKP KZ 5436 17U	840	720	347,7,-
DKP KZ 5436 21U	1018	720	438,5,-
DKP KZ 5436 26U	1240	720	552,6,-
DKP KZ 5436 29U	1373	720	616,9,-
	A	B	

Equipment of body intended for installation of drawers:

- The body is furnished with a central locking system (cylindrical lock) with an integrated function which blocks the opening of several drawers together - it's a protection against overturning.
- The bottom part of the body is furnished with slots for anchoring to the floor. We recommend anchoring the cabinet in case it will be loaded to the limit of its maximum carrying capacity.
- Assembly mouldings on the inner part of bodies allow installing drawers in 1U = 44,45 mm raster.
- Into the body there can be mounted a holder of 19" rack accessories, a stopping device, a leading out moulding for cables and hoses and an output slot. You can also install a panel with slots for cables.

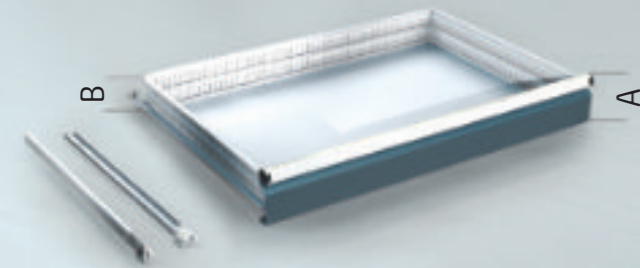
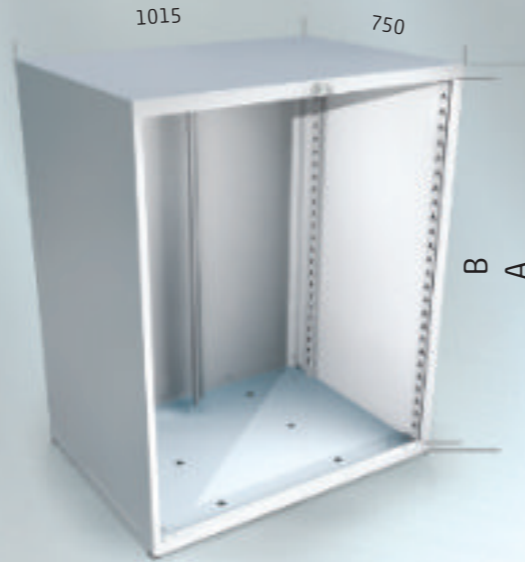

Drawers 5436E, sliding 80%, carrying capacity 90 kg

Order code	Front's height	Side's height	Price (€)
DKP Z 5436 2U A	85	58	116,1,-
DKP Z 5436 3U A	129	102	125,7,-
DKP Z 5436 4U A	174	147	135,4,-
DKP Z 5436 5U A	218	191	145,1,-
DKP Z 5436 6U A	263	236	154,8,-
	A	B	

The drawers are guided in massive slide-rails Fullterer with four ball bearings. These slide-rails are characteristic by an easy and silent running.

The drawers are furnished with a comfort aluminium handle with an installed holder of a safety pin DKP PVZ and with a groove for a label with drawer's contents.

The inner parts of the drawers are pressed and grooved for installing of metal divider sets. Groove spacing is 1E = 17 mm. Useable drawer plan is 910 x 604 mm.

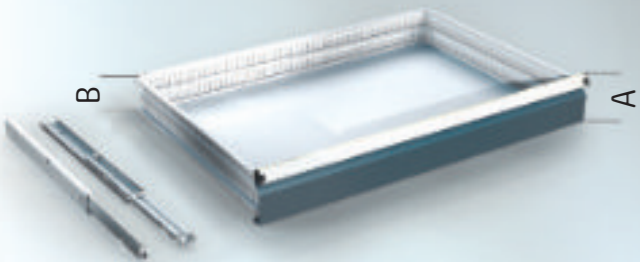

Drawers 5436E, sliding 100%, carrying capacity 65 kg

Order code	Front's height	Side's height	Price (€)
DKP Z 5436 2U B	85	58	150,7,-
DKP Z 5436 3U B	129	102	160,4,-
DKP Z 5436 4U B	174	147	170,1,-
DKP Z 5436 5U B	218	191	179,8,-
DKP Z 5436 6U B	263	236	189,5,-
	A	B	

The drawers are guided in massive slide-rails Fullterer with ten pulleys. These slide-rails are characteristic by an easy and silent running.

The drawers are furnished with a comfort aluminium handle with an installed holder of a safety pin DKP PVZ and with a groove for a label with drawer's contents.

The inner parts of the drawers are pressed and grooved for installing of metal divider sets. Groove spacing is 1E = 17 mm. Useable drawer plan is 910 x 604 mm.

Drawers 5436E, sliding 100%, carrying capacity 180 kg

Order code	Front's height	Side's height	Price (€)
DKP Z 5436 3U C	129	102	206,7,-
DKP Z 5436 4U C	174	147	216,3,-
DKP Z 5436 5U C	218	191	226,1,-
DKP Z 5436 6U C	263	236	235,8,-
	A	B	

The drawers are guided in massive slide-rails Fullterer with ten pulleys. These slide-rails are characteristic by an easy and silent running.

The drawers are furnished with a comfort aluminium handle with an installed holder of a safety pin DKP PVZ and with a groove for a label with drawer's contents.

The inner parts of the drawers are pressed and grooved for installing of metal divider sets. Groove spacing is 1E = 17 mm. Useable drawer plan is 910 x 604 mm.

Divider sets for drawers

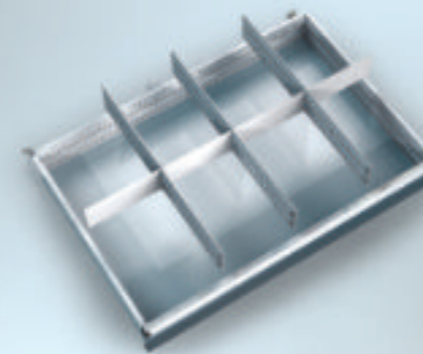

The divider set of the 54E x 36E drawers allows dividing the drawer's inner part into 8 pieces. It contains 3x perforated dividing bar 36E, 3x bar 14E and 1x bar 12E.

The 3U divider set is intended for drawers 3U and 4U, the 5U divider set is intended for drawers 5U and 6U.

Order code	Price (€)
DMZ 5436 2U 8P	41,5,-
DMZ 5436 3U 8P	59,0,-
DMZ 5436 5U 8P	80,0,-

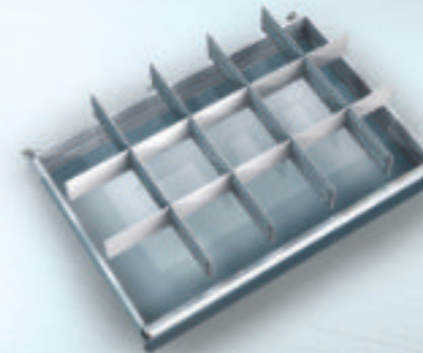

The divider set of the 54E x 36E drawers allows dividing the drawer's inner part into 15 pieces. It contains 4x perforated dividing bar 36E, 8x bar 12E and 2x bar 6E.

The 3U divider set is intended for drawers 3U and 4U, the 5U divider set is intended for drawers 5U and 6U.

Order code	Price (€)
DMZ 5436 2U 15P	73,9,-
DMZ 5436 3U 15P	107,6,-
DMZ 5436 5U 15P	156,6,-

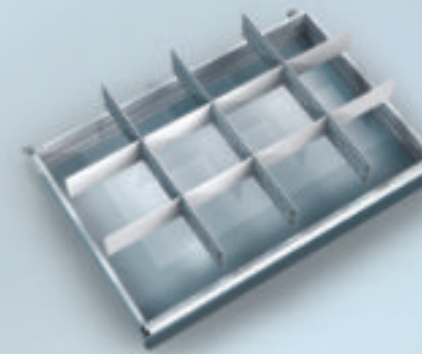

The divider set of the 54E x 36E drawers allows dividing the drawer's inner part into 12 pieces. It contains 3x perforated dividing bar 36E, 6x bar 14E and 2x bar 12E.

The 3U divider set is intended for drawers 3U and 4U, the 5U divider set is intended for drawers 5U and 6U.

Order code	Price (€)
DMZ 5436 2U 12P	50,2,-
DMZ 5436 3U 12P	72,7,-
DMZ 5436 5U 12P	103,5,-

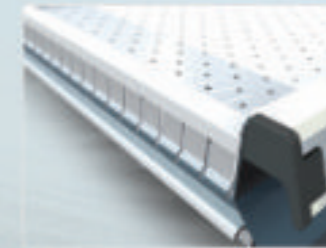

Perforated drawer's bottom

Order code	Price (€)
DKP PDZ 5436	9,6,-

For an extra charge the drawers can be furnished with a perforated bottom. It is useful to combine it with a metal divider set. Bars can be tightly screwed to the drawer's bottom.

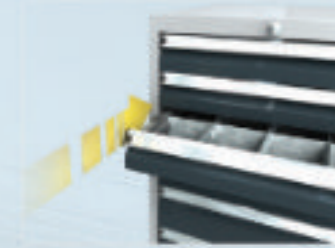

Damping

Order code	Price (€)
TSI 80	35,9,-

The drawers of the DKP line cabinets can be furnished for an extra charge with a system of damped closing. This system is intended for drawers with maximum weighting up to 70 kg. A high quality gas damper ensures secure running and a long lifetime of the system.

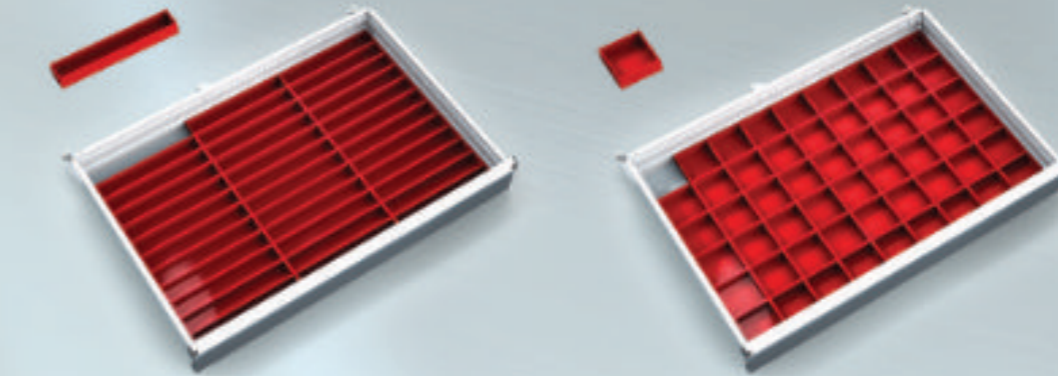

Plastic bins

The plastic bins are intended for dividing the inner drawer's part. On pages 92 and 93 of this catalogue you can find the complete assortment of already configured sets of bins designed directly for particular dimensional lines of drawers. In case that any of those sets do not suit you it is possible to create an individual set. Components for creating the set you will find on page 88.

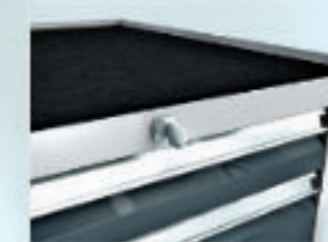

Upper putting surface

Order code	Price (€)
DKP HPR 5436	52,4,-

For an extra charge the body can be furnished with a putting surface with 5 mm width foam filling and with a 20 mm high frame. This frame is a protection against falling of small objects.



Pallet base

Order code	Price (€)
DKP PMP 5436	130,9,-

The pallet base makes the cabinet's manipulation easier.

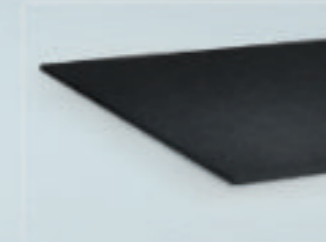

PE foam filling of 5,0 mm height

Order code	Price (€)
DKP PVZ 5436	21,4,-

The foam filling is an efficient protection of gauges and other sensitive devices against their damage.

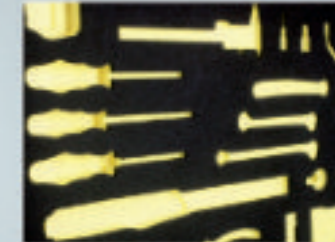

Individual foam filling of drawer

We are able to produce customized foam fillings according to customer's requirement and given electronic drawings. Minimum order number is 20 pcs.

Standard programme dimensional line 5436E

Drawer cabinets 17U

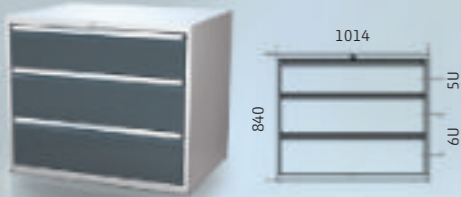

Order code	Sliding	Price (€)
DKP 5436 17U 3AA	80% - 90 kg	802,2,-
DKP 5436 17U 3AB	100% - 65 kg	906,4,-
DKP 5436 17U 3AC	100% - 180 kg	1045,1,-

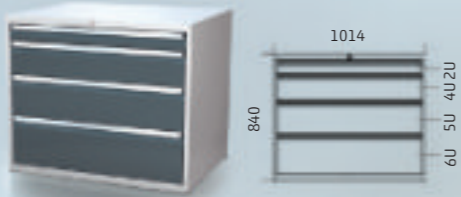

Order code	Sliding	Price (€)
DKP 5436 17U 4AA	80% - 90 kg	899,0,-
DKP 5436 17U 4AB	100% - 65 kg	1037,8,-

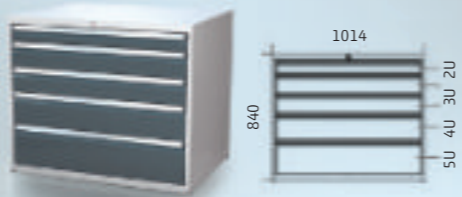

Order code	Sliding	Price (€)
DKP 5436 17U 5AA	80% - 90 kg	995,8,-
DKP 5436 17U 5AB	100% - 65 kg	1169,3,-



Order code	Sliding	Price (€)
DKP 5436 17U 6AA	80% - 90 kg	1092,5,-
DKP 5436 17U 6AB	100% - 65 kg	1300,6,-



Order code	Sliding	Price (€)
DKP 5436 17U 7AA	80% - 90 kg	1189,2,-
DKP 5436 17U 7AB	100% - 65 kg	1432,1,-

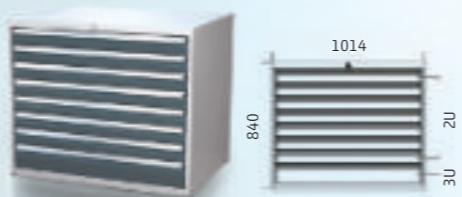

Order code	Sliding	Price (€)
DKP 5436 17U 8AA	80% - 90 kg	1285,9,-
DKP 5436 17U 8AB	100% - 65 kg	1563,5,-

Drawer cabinets 21U

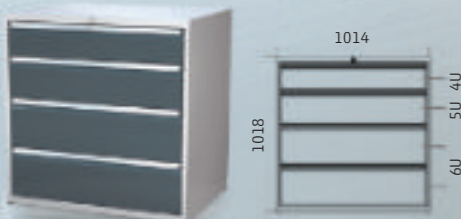

Order code	Sliding	Price (€)
DKP 5436 21U 4AA	80% - 90 kg	1028,5,-
DKP 5436 21U 4AB	100% - 65 kg	1167,3,-
DKP 5436 21U 4AC	100% - 180 kg	1352,3,-

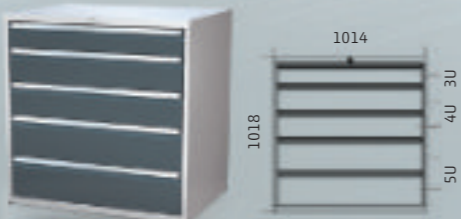

Order code	Sliding	Price (€)
DKP 5436 21U 5AA	80% - 90 kg	1125,2,-
DKP 5436 21U 5AB	100% - 65 kg	1298,7,-
DKP 5436 21U 5AC	100% - 180 kg	1530,0,-

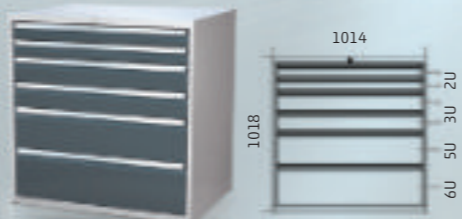

Order code	Sliding	Price (€)
DKP 5436 21U 6AA	80% - 90 kg	1222,0,-
DKP 5436 21U 6AB	100% - 65 kg	1430,1,-

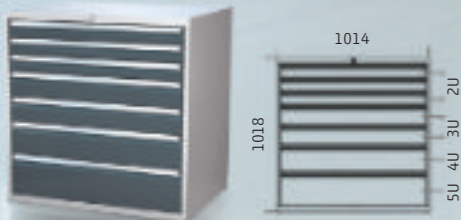

Order code	Sliding	Price (€)
DKP 5436 21U 7AA	80% - 90 kg	1318,6,-
DKP 5436 21U 7AB	100% - 65 kg	1561,5,-

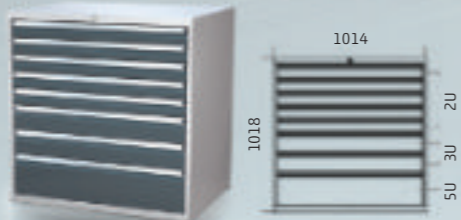

Order code	Sliding	Price (€)
DKP 5436 21U 8AA	80% - 90 kg	1415,4,-
DKP 5436 21U 8AB	100% - 65 kg	1693,0,-

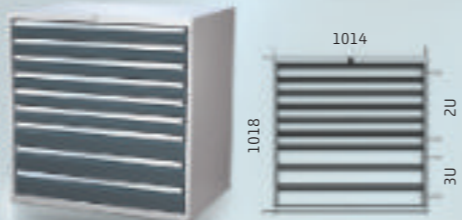

Order code	Sliding	Price (€)
DKP 5436 21U 9AA	80% - 90 kg	1512,2,-
DKP 5436 21U 9AB	100% - 65 kg	1824,4,-

Drawer cabinets 26U

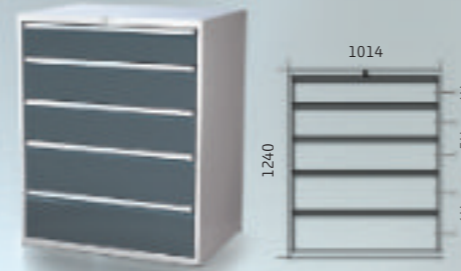

Order code	Sliding	Price (€)
DKP 5436 26U 5AA	80% - 90 kg	1287,8,-
DKP 5436 26U 5AB	100% - 65 kg	1461,2,-
DKP 5436 26U 5AC	100% - 180 kg	1692,6,-

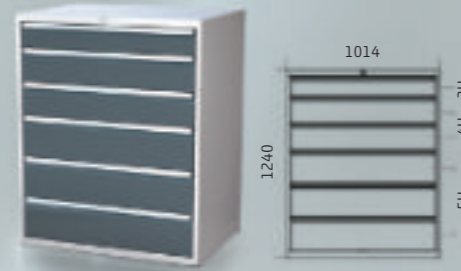

Order code	Sliding	Price (€)
DKP 5436 26U 6AA	80% - 90 kg	1384,5,-
DKP 5436 26U 6AB	100% - 65 kg	1592,7,-
DKP 5436 26U 6AC	100% - 180 kg	1870,3,-

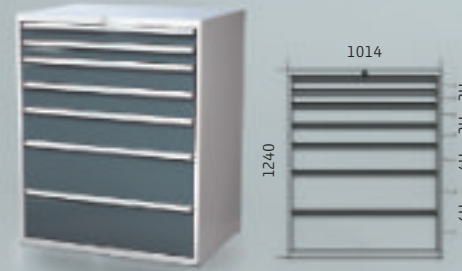

Order code	Sliding	Price (€)
DKP 5436 26U 7AA	80% - 90 kg	1481,2,-
DKP 5436 26U 7AB	100% - 65 kg	1724,1,-

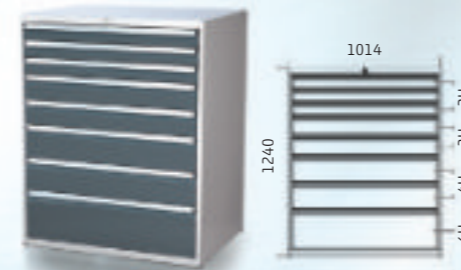

Order code	Sliding	Price (€)
DKP 5436 26U 8AA	80% - 90 kg	1578,0,-
DKP 5436 26U 8AB	100% - 65 kg	1855,5,-

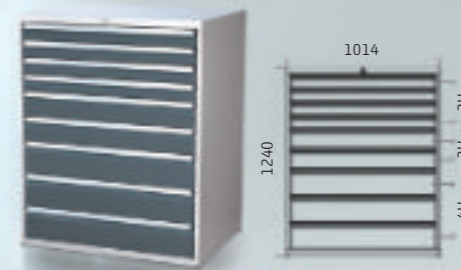

Order code	Sliding	Price (€)
DKP 5436 26U 9AA	80% - 90 kg	1674,7,-
DKP 5436 26U 9AB	100% - 65 kg	1987,0,-

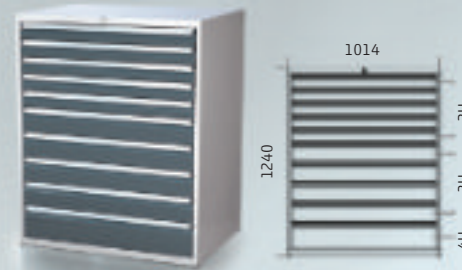

Order code	Sliding	Price (€)
DKP 5436 26U 10AA	80% - 90 kg	1771,4,-
DKP 5436 26U 10AB	100% - 65 kg	2118,3,-

Drawer cabinets 29U

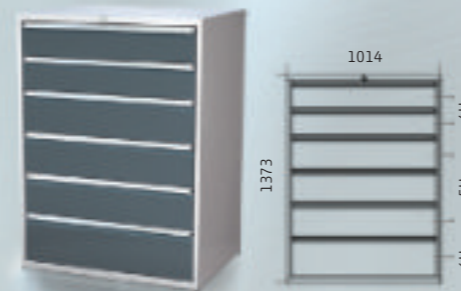

Order code	Sliding	Price (€)
DKP 5436 29U 6AA	80% - 90 kg	1477,8,-
DKP 5436 29U 6AB	100% - 65 kg	1686,0,-
DKP 5436 29U 6AC	100% - 180 kg	1963,6,-

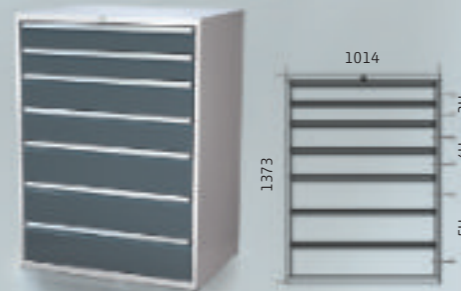

Order code	Sliding	Price (€)
DKP 5436 29U 7AA	80% - 90 kg	1574,5,-
DKP 5436 29U 7AB	100% - 65 kg	1817,4,-
DKP 5436 29U 7AC	100% - 180 kg	2141,3,-

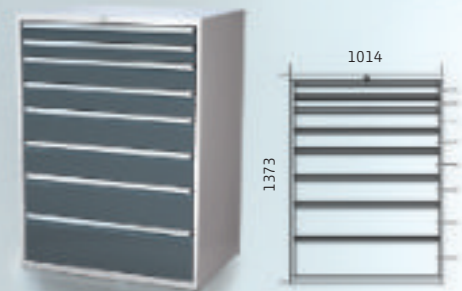

Order code	Sliding	Price (€)
DKP 5436 29U 8AA	80% - 90 kg	1671,3,-
DKP 5436 29U 8AB	100% - 65 kg	1948,9,-

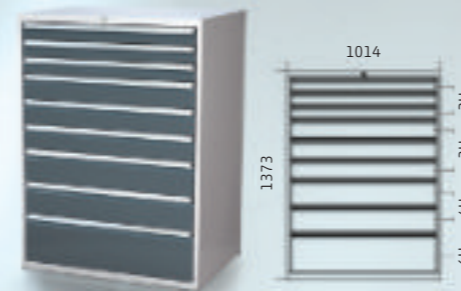

Order code	Sliding	Price (€)
DKP 5436 29U 9AA	80% - 90 kg	1768,1,-
DKP 5436 29U 9AB	100% - 65 kg	2080,3,-

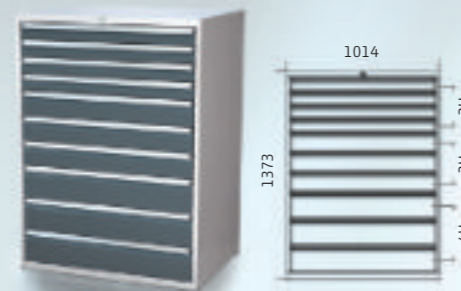

Order code	Sliding	Price (€)
DKP 5436 29U 10AA	80% - 90 kg	1864,8,-
DKP 5436 29U 10AB	100% - 65 kg	2211,8,-

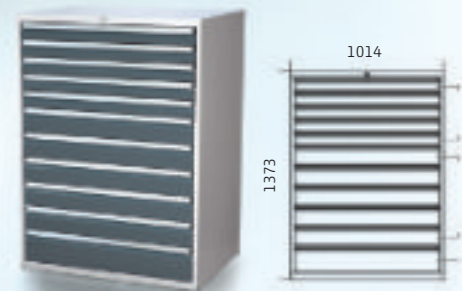

Order code	Sliding	Price (€)
DKP 5436 29U 11AA	80% - 90 kg	1961,5,-
DKP 5436 29U 11AB	100% - 65 kg	2343,1,-



Drawer cabinets PROFI

dimensional line	2727E	3627E	4527E	5427E
	3636E	4536E	5436E	

Drawer cabinets UNI

Workshop trolleys

Workbenches

ALCERA	ALPEDE
ALSOR	ALNAK

Workshop cabinets

system	universal
warehouse	

Perfo systems

mobile
stationary

Holders for tools

Plastic bins

Computer cabinets

Fire extinguishers

Surface treatment

Drawer cabinets UNI

The UNI line drawer cabinets have a simpler constructional base than the PROFI line drawer cabinets so that they are suitable for lower weighting of drawers. They can be used as a part of workbenches at assembly and wrapping workplaces at services and warehouses.

The bodies are constructed as solid weldments, they have installed a central locking system and in the bottom or in the back wall they are furnished with slots for anchoring to the wall or to the floor.

The drawers of the UNI line cabinets are guided in telescopic slide-rails with 100% sliding and with a carrying capacity of 40 kg. They are furnished with an aluminium handle which has a groove for inserting a label with drawer's contents. Inner drawer's dimensions are 24E x 27E, where 1E = 17 mm, useable drawer plan is 408 x 459 (449) mm. The drawers are perforated in the bottom and in the frame in 1E raster so that metal dividing bars can be used. The metal dividing bars can be placed in one direction only. The inner space of the drawers can be further furnished with plastic bins, see page 84, or with a foam filling designed according to the disposition given by the customer.



ESD treatment

For an extra charge you can order drawer cabinets with ESD surface treatment. The extra charge is calculated individually according to the chosen cabinets and their number.



Order code	Price (€)	Order code	Price (€)
DKU 38U 12A	1026,9,-	DKU 38U 17A	1211,2,-

Order code	Price (€)	Order code	Price (€)
DKU 2 38U 12A	1946,5,-	DKU 2 38U 17A	2436,3,-

Dividing bar for drawers

Order code	Drawer	Price (€)
DKU DP 2U S	2U	5,1,-
DKU DP 3U S	3U	7,7,-
DKU DP 4U S	4U	9,4,-
DKU DP 5U S	5U	10,4,-
DKU DP 6U S	6U	12,0,-

Universal cabinets for workbenches

Order code	Price (€)	Order code	Price (€)	Order code	Price (€)	Order code	Price (€)
DKU 3U 1A S	130,0,-	DKU 6U 2A S	284,0,-	DKU 6U 2B S	284,0,-	DKU 6U 3A S	332,9,-

Order code	Price (€)	Order code	Price (€)	Order code	Price (€)	Order code	Price (€)
DKU 13U 1D	204,4,-	DKU 13U 3A S	365,7,-	DKU 13U 4A S	414,7,-	DKU 13U 5A S	463,7,-

Order code	Price (€)	Order code	Price (€)	Order code	Price (€)	Order code	Price (€)
DKU 17U 1D	243,3,-	DKU 17U 3A S	394,3,-	DKU 17U 4A S	443,2,-	DKU 17U 5A S	492,3,-



Drawer	Front's height (mm)	Side's height (mm)
2U	85	64
3U	129	108
4U	174	153
5U	218	197
6U	263	242
	A	B

Order code	Price (€)	Order code	Price (€)
DKU 2 17U 5A	913,0,-	DKU 2 17U 8A	1207,0,-

Order code	Price (€)	Order code	Price (€)
DKU 3 17U 5A	1360,0,-	DKU 3 17U 8A	1800,9,-

Trolleys DVU

The UNI line trolleys are intended for transport of components and tools. They are useful for setup men, service workers and CNC machines operators.

The bodies of the trolleys are constructed as solid weldments, they have a central locking system and they are furnished with a wheelframe with a pair of fixed and a pair of revolving castors with a brake. The castor's diameter is 100 mm.

The drawers are guided in telescopic slide-rails with 100% sliding and with a carrying capacity of 40 kg. They are furnished with an aluminium handle which has a groove for inserting a label with drawer's contents. The inner drawer's dimensions are 36E x 26E, where 1E = 17 mm, useable drawer plan is 612 x 391 (381) mm. The drawers are perforated in the bottom and in the frame in 1E raster so that metal dividing bars can be mounted. The metal dividing bars can be placed in one direction only. The inner space of the drawers can be further furnished with plastic bins, see page 88, or with a foam filling designed according to the disposition given by the customer. Versions with doors or a version with a flat trolley function are also available.

Basic version

The standard versions of trolleys are in their upper part furnished with a putting surface filled with a 5,0 mm foam. Along the putting surface there is a frame which makes a protection against falling of small objects.

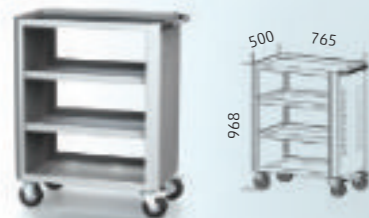

Order code DVU 3623 17U PV Price (€) 266,4,-



Order code DVU 3623 17U 1D Price (€) 327,6,-



Order code DVU 3623 17U 3A Price (€) 473,9,-



Order code DVU 3623 17U 4A Price (€) 524,7,-

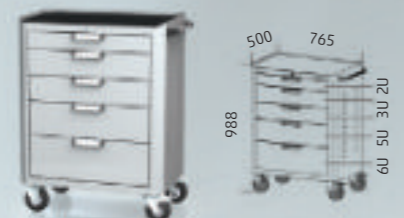

Order code DVU 3623 17U 5A Price (€) 575,5,-

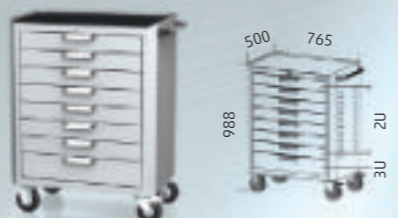

Order code DVU 3623 17U 8A Price (€) 728,0,-

Version for CNC carriers transport

The DSP CNC trolleys for CNC carriers transport are in their upper part furnished with adapters intended for fixing carriers with boxes for storing milling cutters. The boxes are available for all the common used clamping systems and you can find them on



Order code DVU 3623 13UN PV Price (€) 270,5,-



Order code DVU 3623 13UN 1D Price (€) 330,3,-



Order code DVU 3623 13UN 3A Price (€) 489,9,-

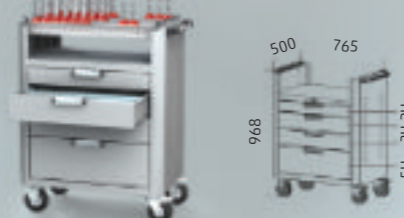

Order code DVU 3623 13UN 4A Price (€) 540,7,-



Drawer	Front's height (mm)	Side's height (mm)
2U	4,1,-	3,1,-
3U	6,2,-	4,3,-
4U	8,4,-	6,1,-
5U	10,5,-	7,9,-
6U	12,7,-	9,7,-
	A	B

Dividing bar for drawers

Order code	Drawer	Price (€)
DVU DP 2U S	2U	7,1,-
DVU DP 3U S	3U	10,7,-
DVU DP 4U S	4U	13,1,-
DVU DP 5U S	5U	14,6,-
DVU DP 6U S	6U	16,7,-



	Drawer cabinets PROFI				Drawer cabinets UNI	Workshop trolleys	Workbenches		Workshop cabinets		Perfo systems	Holders for tools	Plastic bins	Computer cabinets	Fire extinguishers	Surface treatment
dimensional line	2727E	3627E	4527E	5427E			ALCERA	ALPEDE	system	universal	mobile					
	3636E	4536E	5436E				ALSOR	ALNAK	warehouse		stationary					

Workbenches

We produce four basic model lines of workbenches. Every single model line is designed to meet a wide range of requirements of a modern workplace. Basic information on their construction and technical parameters you will find in the description of each version.



Workbenches alcera page 48-53

The basic supporting members of the ALCERA workbenches are their feet made of profiled steel sheets. There are unadjustable, adjustable or mobile feet available. To ensure the stability of the lower construction there are used horizontal feet joins or corner reinforcing elements which are installed between the foot and the desk. As supporting members there can be also used workshop cabinets of the PROFI or UNI line in 17U version with 840 mm height. The height of the work surface, when a 40 mm desk is used, is 880 mm. In the section of individual accessories you will find a wide assortment of elements for lower or upper construction of the workbench. Due to these elements you can assembly a workbench which will fully meet the requirements of a particular workplace. In the section of the ALCERA standard workbench sets you will find the most common versions of already

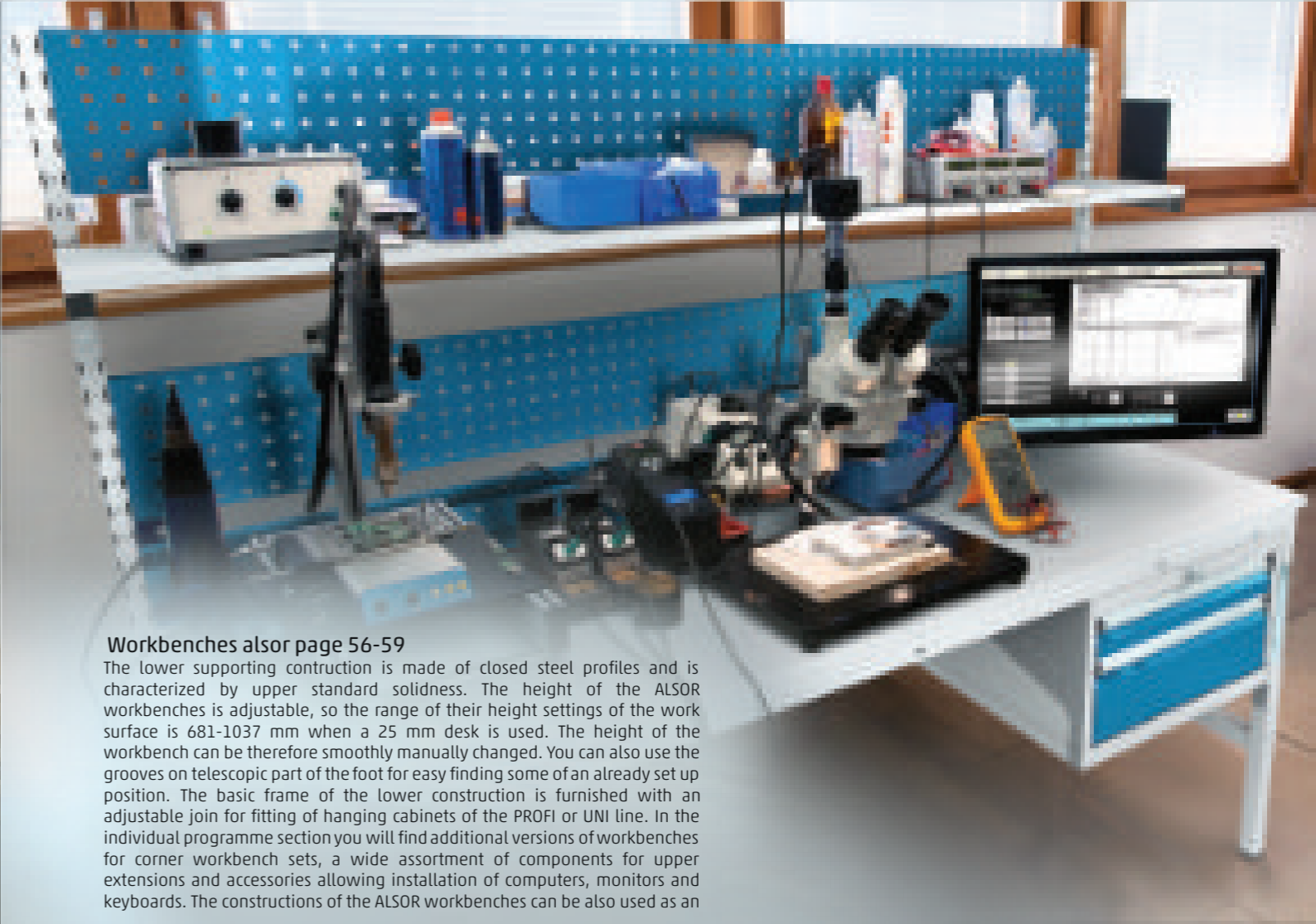

Workbenches also page 56-59

The lower supporting construction is made of closed steel profiles and is characterized by upper standard solidness. The height of the ALSOR workbenches is adjustable, so the range of their height settings of the work surface is 681-1037 mm when a 25 mm desk is used. The height of the workbench can be therefore smoothly manually changed. You can also use the grooves on telescopic part of the foot for easy finding some of an already set up position. The basic frame of the lower construction is furnished with an adjustable join for fitting of hanging cabinets of the PROFI or UNI line. In the individual programme section you will find additional versions of workbenches for corner workbench sets, a wide assortment of components for upper extensions and accessories allowing installation of computers, monitors and keyboards. The constructions of the ALSOR workbenches can be also used as an



Workbenches alpede page 54-55

The basic elements of the supporting construction of the ALPEDE workbenches are massive bases on feet or pallet bases. The bases are furnished with PROFI or UNI cabinets in 13U version with 662 mm height. The whole workbench is then, due to its reinforced construction of its base, easily movable using common handling devices. The ALPEDE workbenches are designed especially for working in standing position. The height of the work surface, when a 40 mm desk is used, is 880 mm. The main advantage of the ALPEDE workbenches is their resistance and bulky and ingenious deposit space. Constructional elements for the upper extensions for the workbenches of the ALPEDE and ALCERA lines are common. In the section of the ALPEDE



Workbenches alnak page 60-61

The height of the ALNAK workbenches is electrically adjustable in range of 660 - 1310 mm when a 25 mm desk is used. The maximum height setting speed is 38 mm/s, the carrying capacity of the workbench is 200 kg. Electrically set ergonomic workplace finds its place at demanding production plants as well as at offices. The advantage of the personal setting is lower work difficulties. The workplace can be easily adapted to different work activities and to the worker's physical proportions. Due to these advantages the work productivity is increased and the risk of an occupational disease is decreased. The ALNAK workbenches can be furnished with different controlling systems. The easiest ones have buttons for moving up and down. The more comfort version is furnished with a display showing actual height and with memory of 3 height position and with an electronic limiter of uplift.



dimensional line	2727E	3627E	4527E	5427E
	3636E	4536E	5436E	

ALCERA	ALPEDE
ALSOR	ALNAK

system	universal
warehouse	

mobile
stationary

Energy channels



The energy channels are designed as distributors allowing installation of components intended for placing on DIN moulding and of 19" PC or telecommunication components. They are also intended for installation of 250V or 400V inbuilt sockets. In our assortment there are also front panels with couplers for compressed air distribution. The energy channels are prepared for placing on holders of EUROPERFO panels ALFA3.

If you need, the energy channels can be furnished with following extra charge items:

- stop button
- toggle switch for controlling of light of the upper extension
- data socket
- transformer and socket for 12V or 24V
- USB socket

Further components according to customer's requirements.



Order code	Price (€)
EGK 550 1U K1	184,1,-

Energy channel EGK KOR 550 1U furnished with one RCK 2U socket moulding Z7V 19 1U with 7 pcs of 230V sockets and a switch.



Order code	Price (€)
EGK 550 2U K1	198,8,-

Energy channel EGK KOR 550 2U furnished with one RCK 2U 4ZZ panel with 4 pcs of 230V inbuilt industry sockets.



Order code	Price (€)
EGK 550 2U K2	205,6,-

Energy channel EGK KOR 550 2U furnished with one RCK 2U 3ZZ 1TZ panel with 3 pcs of 230V inbuilt industry sockets and with 1 pc of three-phase socket 5 x 16A.



Order code	Price (€)
EGK 550 2U K3	97,3,-

Energy channel EGK KOR 550 2U furnished with one RCK 2U 2V panel with 2 pcs of couplers for compressed air.



Order code	Price (€)
EGK 1500 2U L1	258,8,-

Energy channel EGK KOR 1500 2U furnished with one RCK 2U 4 ZZ panel with 4 pcs of inbuilt industry sockets 230V, with one RCK 2U 1JJ panel with one-phase circuit breaker B 10A and a cover RCK 2U KP.



Order code	Price (€)
EGK 1500 2U K2	296,5,-

Energy channel EGK KOR 1500 2U furnished with one RCK 2U 3ZZ 1TZ panel with 3 pcs of inbuilt industry sockets 230V, with one three-phase socket 5x 16A, with 1x RCK 2U 1JJ panel with one-phase circuit breaker B 10A and 1x three-phase circuit breaker B 16A and a cover RCK 2U KP.



Order code	Price (€)
EGK 750 2U K1	200,8,-

Energy channel EGK KOR 750 2U furnished with one RCK 2U 4ZZ panel with 4 pcs of 230V inbuilt industry sockets.



Order code	Price (€)
EGK 750 2U K2	207,7,-

Energy channel EGK KOR 750 2U furnished with one RCK 2U 3ZZ 1TZ panel with 3 pcs of 230V inbuilt industry sockets and with 1 pc of three-phase socket 5 x 16A.



Order code	Price (€)
EGK 750 2U K3	99,3,-

Energy channel EGK KOR 750 2U furnished with one RCK 2U 2V panel with 2 pcs of couplers for compressed air.



Order code	Price (€)
EGK 1500 2U K3	330,5,-

Energy channel EGK KOR 1500 2U furnished with a RCK 2U 3ZZ 1TZ panel with 3 pcs of inbuilt industry sockets 230V, with one three-phase socket 5x 16A, with a RCK 2U 1JJ 1TJ panel with one-phase circuit breaker B 10A and 1x three-phase circuit breaker B 16A and 1x RCK 2U 2V panel with 2 pcs of couplers for compressed air.



Order code	Price (€)
EGK 1000 2U K1	230,2,-

Energy channel EGK KOR 1000 2U furnished with one RCK 2U 4ZZ panel with 4 pcs of 230V inbuilt industry sockets and one RCK 2U 1JJ panel with a one-phase circuit breaker B 10A.



Order code	Price (€)
EGK 1000 2U K2	267,9,-

Energy channel EGK KOR 1000 2U furnished with one RCK 2U 3ZZ 1TZ panel with 3 pcs of 230V inbuilt industry sockets, with one three-phase socket 5x 16A and with one RCK 2U 1JJ panel with a one-phase circuit breaker B 10A and with a three-phase circuit breaker B 16A.



Order code	Price (€)
EGK 1000 2U K3	265,2,-

Energy channel EGK KOR 1000 2U furnished with one RCK 2U 6ZZ panel with 6 pcs of 230V inbuilt industry sockets without protection and with one RCK 2U 2V panel with 2 pcs of couplers for compressed air.



Order code	Price (€)
EGK 2000 2U K1	331,7,-

Energy channel EGK KOR 2000 2U furnished with one RCK 2U KP cover, with one RCK 2U 4ZZ panel with 4 pcs of 230V inbuilt industry sockets, with one RCK 2U 1TZ panel with 1x three-phase inbuilt socket 5x16A and with one RCK 2U 1JJ 1TJ panel with a one-phase circuit breaker B 10A and with 1x three-phase circuit breaker B 16A.



Order code	Price (€)
EGK 2000 2U K2	335,8,-

Energy channel EGK KOR 2000 2U furnished with one RCK 2U KP cover, with one RCK 2U 6ZZ panel with 6 pcs of 230V inbuilt industry sockets, with one RCK 2U 1TZ panel with 1x three-phase inbuilt socket 5x 16A and with one RCK 2U 2V panel and with 2 pcs of couplers for compressed air.



Order code	Price (€)
EGK 2000 2U K3	365,8,-

Energy channel EGK KOR 2000 2U furnished with one RCK 2U KP cover, with one RCK 2U 4ZZ panel with 4 pcs of 230V inbuilt industry sockets, with one RCK 2U 1TZ panel with 1x three-phase inbuilt socket 5x 16A, with one RCK 2U 1JJ 1TJ panel with a one-phase circuit breaker B 10A and with 1x three-phase circuit breaker B 16A and with one RCK 2U 2V panel with 2 pcs of couplers for compressed air.



Order code	Price (€)
EGK 2000 2U L1	277,9,-

Energy channel EGK KOR 2000 2U furnished with one RCK 2U 4 ZZ panel with 4 pcs of inbuilt industry sockets 230V, with one RCK 2U 1JJ panel with one-phase circuit breaker B 10A and 2 pcs of covers RCK 2U KP.



Individual programme of components of the ALCERA and ALPEDE workbenches

Feet

Unadjustable foot

The foot is constructed as a massive weldment, it is furnished with reinforcing elements and with slots for connecting it with a workbench's desk. Its max. load is 500 kg and its height is 840 mm.



Order code	Version	Price (€)
DP NOH 17U N	standard version	71,4,-
DP NOH 17U N ESD	ESD version	91,8,-

Adjustable foot

The foot is constructed as a massive weldment, it is furnished with reinforcing elements and with slots for connecting it with a workbench's desk. Its max. load is 350 kg and its height is 660-1015 mm.



Order code	Version	Price (€)
DP NOH 17U S	standard version	123,8,-
DP NOH 17U S ESD	ESD version	147,6,-

Mobile foot

The foot is constructed as a massive weldment, it is furnished with reinforcing elements and with slots for connecting it with a workbench's desk. Its max. load is 150 kg and its height is 840 mm. The castors' diameter is 125 mm, material PP.



Order code	Version	Price (€)
DP NOH 17U PP	fixed castor	123,1,-
DP NOH 17U PB	revolving castor with a brake	198,8,-

Join

Feet join

The feet join is designed to reinforce the workbench's construction. You can mount it in various positions.

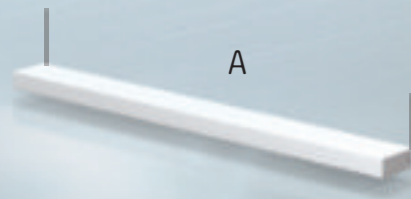

Order code	Version	Length (mm)	Price (€)
DP TRN 150 N	standard version	1500	32,7,-
DP TRN 150 N ESD	ESD version	1500	38,8,-
DP TRN 200 N	standard version	2000	35,4,-
DP TRN 200 N ESD	ESD version	2000	42,8,-

Lower deposit shelf

The shelves are to be mounted in between of the feet's lower bars or into the side slots of the PROFIL line cabinets in 17U version. The reinforced shelf's construction has surface max. load 80 kg.



Order code	Length (mm)	Depth (mm)	Price (€)
DP POL 1200 NN 1	1135	575	50,6,-
DP POL 1500 NN 1	1435	575	56,3,-
DP POL 2000 NN 1	1935	575	65,8,-
DP POL 1200 NKP 2	580	575	34,5,-
DP POL 1500 NKP 2	880	575	42,7,-
DP POL 2000 NKP 2	1380	575	54,5,-
DP POL 1500 KKP 3	330	575	41,6,-
DP POL 2000 KKP 3	830	575	53,3,-

Bases

Base with feet

The base is intended for modular versions of workbenches. It can be combined with the DKP 2727 line cabinets or with the DKU line cabinets of 13U height.



Order code	Version	Price (€)
DPP NPO 2	for 2 DKP cabinets	130,6,-
DPP NPO 3	for 3 DKP cabinets	190,7,-
DPU NPO 3	for 3 DKB cabinets	150,2,-
DPU NPO 4	for 4 DKB cabinets	219,3,-

Pallet base

The pallet base is intended for modular versions of workbenches. It can be combined with the DKP 2727 line cabinets or with the DKU line cabinets of 13U height.

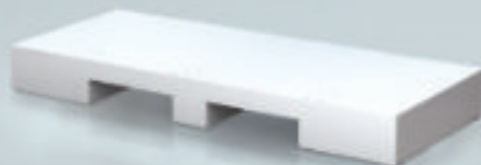

Order code	Version	Price (€)
DPP MPO 2	for 2 DKP cabinets	150,2,-
DPP MPO 3	for 3 DKP cabinets	219,3,-
DPU MPO 3	for 3 DKB cabinets	172,7,-
DPU MPO 4	for 4 DKB cabinets	252,1,-

Mobile base

The mobile base is intended for modular versions of workbenches. It is to be combined with two cabinets of the DKP 2727 line of 13U height. It has 2 fixed castors and 2 revolving castors with a brake, both of 100 mm diameter. A handle is the part of supply.



Order code	Version	Price (€)
DPP PPO 2	for 2 DKP cabinets	277,2,-

Accessories

Holders of EUROPERFO panels and accessories

Stable profiled holder in L shaped. To be mounted by a screw joint in the bottom part of the work desk.

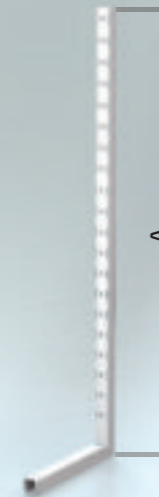

Order code	Height (mm)	Upper extension max. load (kg)	Price (€)
DP DEP 10U S	444	15	23,8,-
DP DEP 15U S	667	15	30,6,-
DP DEP 20U S	889	15	33,3,-
DP DEP 25U S	1067	15	37,4,-
DP DEP 30U S	1290	15	41,8,-
DP DEP 10U B	444	30	31,9,-
DP DEP 15U B	667	30	45,1,-
DP DEP 20U B	889	30	57,6,-
DP DEP 25U B	1067	30	68,5,-
DP DEP 30U B	1290	30	78,4,-

Corner reinforcing element

It can substitute a feet join and it is mounted between the desk and a foot so that the construction of the workbench is stabilized.



Order code	Price (€)
DP RVP ND	17,7,-

ESD elements



Order code	Name	Price (€)
ESD PZK 1	earthing cable	9,9,-
ESD PZBA 2	earthing box A	18,8,-
ESD PZBB 3	earthing box B	44,8,-
ESD PZN 4	earthing bracelet	12,6,-



alcera Individual programme of components of the ALCERA and ALPEDE workbenches

Illuminating ramp

The hanging holder of the illuminating body is to be mounted on holders of the EUROPERFO panels of the DEP line. In case of working sitting we recommend installing a lampshade which protects the workers from glare. The illuminating bodies holders are prepared for installation of the Trevos lamps of the Prima line. We recommend using the lamps with an electronic control gear with IP 66 protection.

The lamp's price does not include the price of a source. For an extra charge we can supply standard or LED fluorescent lamp fixtures.



Order code	Length (mm)	Depth (mm)	Price (€)
DP DZA 1500	1500	432	47,3,-
DP DZA 2000	2000	432	50,2,-
DP SZT 1500	lampshade, length 1500		25,8,-
DP SZT 2000	lampshade, length 2000		31,5,-
P 136 AC E 1x36W EVG	one-tube body		80,2,-
P 236 PC E 2x36W EVG	two-tube body		100,0,-
ALMAX 236 E	AL two-tube body		241,3,-
	toggle switch for EVG lamps		11,4,-

Name

Hinged shelves - screw joint

We standardly produce shelves in two widths and three depths. The part of the supply are also assembling consols for installation in holders of the EUROPERFO panels of the DEP line. The shelves have in their front parts a stop moulding and a moulding for description. The shelf's slope can be set in several positions. Mounting by screw joints.

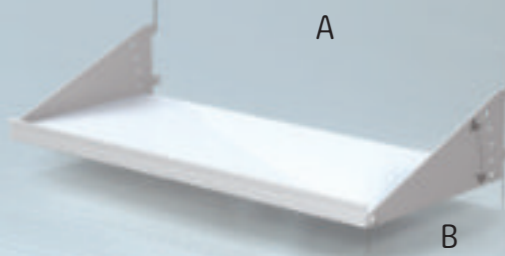

Order code	Length (mm)	Depth (mm)	Price (€)
DP POL 200 702 P	715	240	40,8,-
DP POL 300 702 P	715	340	52,7,-
DP POL 400 702 P	715	440	64,6,-
DP POL 200 952 P	965	240	49,8,-
DP POL 300 952 P	965	340	64,3,-
DP POL 400 952 P	965	440	78,8,-

A

B



Antistatic pad for shelves

For shelves of the ESD workbenches we recommend using an antistatic pad. The pad has to be earthed by an earthing cable.

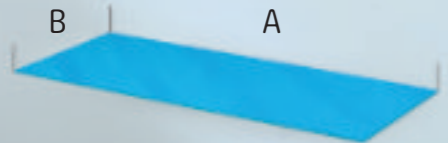

Order code	Length (mm)	Depth (mm)	Price (€)
ESD G POL 200 702	200	702	9,8,-
ESD G POL 300 702	300	702	14,4,-
ESD G POL 400 702	400	702	19,1,-
ESD G POL 200 952	200	952	13,1,-
ESD G POL 300 952	300	952	19,4,-
ESD G POL 400 952	400	952	25,6,-
ESD PZK	*		8,9,-

A

B

* earthing cable

Hanging system

The holder of the hanging system is intended for mounting on the holders of the EUROPERFO panels of the DEP line. The holder is furnished with slots for mounting a 33 x 31 mm guiding profile in 50 mm spacing. The max. load of the construction is 15 kg. The profile can be furnished with two- or four-casters steel trolleys. The DZK version allows installing an illuminating body.



Order code	Length (mm)	Depth (mm)	Price (€)	
DP DZS 1500	1	1500	432	78,5,-
DP DZS 2000	1	2000	432	85,0,-
DP DZK 1500	2	1500	432	102,7,-
DP DZK 2000	2	2000	432	111,9,-
DP DZS 2V	3	trolley with two castors		17,0,-
DP DZS 4V	4	trolley with four castors		28,2,-

Name

Hinged shelves - revolving handle

We standardly produce shelves in two widths and three depths. The part of the supply are also assembling consols for installation in holders of the EUROPERFO panels of the DEP line. The shelves have in their front parts a stop moulding and a moulding for description. The shelf's slope can be easily set in several positions by using the revolving handle.

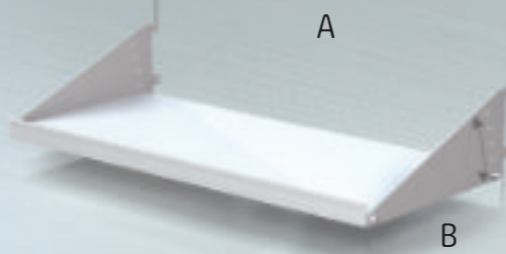

Order code	Length (mm)	Depth (mm)	Price (€)
DP POL 200 702 S	720	240	62,6,-
DP POL 300 702 S	720	340	74,5,-
DP POL 400 702 S	720	440	86,4,-
DP POL 200 952 S	970	240	76,3,-
DP POL 300 952 S	970	340	90,9,-
DP POL 400 952 S	970	440	105,4,-

A

B

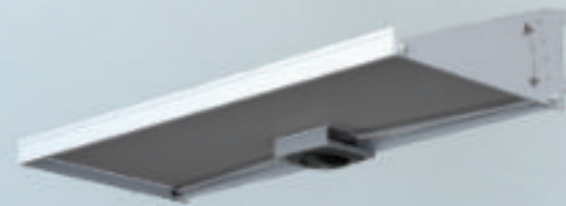

EUROPERFO® panels

The profiled sheet board is intended for mounting to the EUROPERFO - DPA DEP XXX holders. The panels are standardly supplied in zinc-galvanized version. The perforation for placing of the holders for tools is made through square slots 10 x 10 mm, spacing is 38 mm.

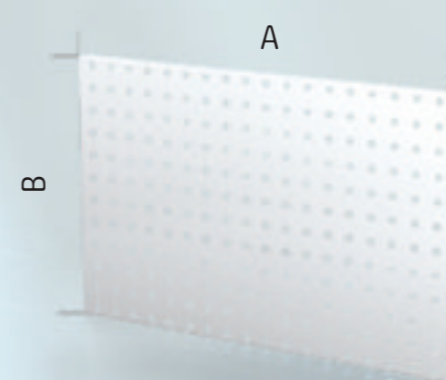

Order code	Height (mm)	Length (mm)	Price (€)
DP EP 5U 704	222	704	25,2,-
DP EP 10U 704	444	704	39,5,-
DP EP 5U 954	222	954	32,7,-
DP EP 10U 954	444	954	51,0,-

A

B

EUROBOX® panels

The profiled sheet board is intended for mounting to the EUROPERFO - DPA DEP holders. The panels are standardly supplied in zinc-galvanized version. The board is pressed in 50 x 20 mm, it is designed for plastic bins installation.

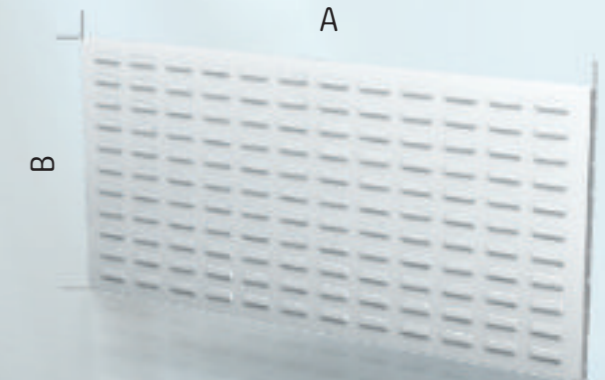

Order code	Height (mm)	Length (mm)	Price (€)
DP EB 5U 704	222	704	35,2,-
DP EB 10U 704	444	704	55,2,-
DP EB 5U 954	222	954	45,7,-
DP EB 10U 954	444	954	71,4,-

A

B

Hanging cupboards

The hanging cupboard increases the secured deposit capacity of the workplace. It is furnished with wing doors lockable by a C1 cylindrical lock with two-point locking system. It is also furnished with EUROPERFO panels on its inner door parts and with an adjustable shelf. The cupboard has in its side walls slots for fitting to the DP DEP holders, in the back wall there are slots for fixation to the wall. Due to the security reasons the fixation to the wall is mandatory.

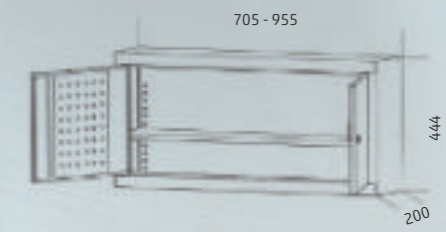

Order code	Dimensions (mm)	Price (€)
DP ZS 705 10U	444 x 705 x 200	200,1,-
DP ZS 955 10U	444 x 955 x 200	228,3,-



dimensional line	2727E	3627E	4527E	5427E
	3636E	4536E	5436E	

Drawer cabinets UNI

Workshop trolleys

ALCERA	ALPEDE
ALSOR	ALNAK

system	universal
warehouse	

Perfo systems	mobile	stationary
---------------	--------	------------

Holders for tools

Plastic bins

Computer cabinets

Fire extinguishers

Surface treatment

alcera UNI



Workbenches alcera UNI - standard versions

- Technical parameters:
- The work desk is made of 40 mm waterproof glued beech chipboard.
 - The height of the work surface of unadjustable versions is 880 mm.
 - Range of manual height settings of the work surface of versions with adjustable feet is 700 - 1055 mm.
 - UNI cabinets with lockable doors and shelves of surface max. load 40 kg, shelves are adjustable after 25 mm.
 - The UNI cabinets with 100% telescopic drawers, drawer's surface max. load 40 kg, central locking, an aluminium handle with a groove for inserting a label with drawer's contents, drawers perforated on their sides and bottoms for using metal dividing bars in transverse direction.
 - ESD versions of ALCERA workbenches can be ordered for the below given extra charge.

	Length of workbench (mm)	Extra charge (€)
	1500	172,2,-
	2000	194,1,-

The ESD set consists of a 27 mm high antistatic pad, a snap button, an earthing cable and an ESD earthing box A.

alcera PROFI

Workbenches alcera PROFI - standard versions

- Technical parameters:
- The workdesk is made of 40 mm waterproof glued beech chipboard.
 - The height of the work surface of unadjustable versions is 880 mm.
 - Range of manual height settings of the work surface of versions with adjustable feet is 700 - 1055 mm.
 - PROFI cabinets with lockable doors and handles and shelves of surface max. load 50 kg, shelves are adjustable after 25 mm.
 - The PROFI cabinets with 80% telescopic drawers, drawer's surface max. load 90 kg, central locking with a blocation of opening several drawers together, an aluminium handle with a groove for inserting a label with drawer's contents, drawers perforated on their sides for using metal dividing bars.
 - Cabinets with 100% telescopic drawers and max. load 65 or 180 kg can be ordered for an extra charge.



Order code	Width (mm)	Price (€)
alcera Z15 K01	1500	448,6,-
alcera Z20 K01	2000	508,6,-



Order code	Width (mm)	Price (€)
alcera U15 K01	1500	578,6,-
alcera U20 K01	2000	638,6,-



Order code	Width (mm)	Price (€)
alcera U15 K02	1500	732,6,-
alcera U20 K02	2000	792,6,-



Order code	Width (mm)	Price (€)
alcera U15 K03	1500	781,6,-
alcera U20 K03	2000	841,5,-



Order code	Width (mm)	Price (€)
alcera P15 K01	1500	654,4,-
alcera P20 K01	2000	714,4,-



Order code	Width (mm)	Price (€)
alcera P15 K02	1500	831,3,-
alcera P20 K02	2000	891,3,-



Order code	Width (mm)	Price (€)
alcera P15 K03	1500	831,3,-
alcera P20 K03	2000	891,3,-



Order code	Width (mm)	Price (€)
alcera P15 K04	1500	972,5,-
alcera P20 K04	2000	1032,5,-



Order code	Width (mm)	Price (€)
alcera U15 K04	1500	483,0,-
alcera U20 K04	2000	540,2,-



Order code	Width (mm)	Price (€)
alcera U15 K05	1500	634,0,-
alcera U20 K05	2000	691,3,-



Order code	Width (mm)	Price (€)
alcera U15 K06	1500	683,0,-
alcera U20 K06	2000	740,3,-



Order code	Width (mm)	Price (€)
alcera U15 K07	1500	732,0,-
alcera U20 K07	2000	789,3,-



Order code	Width (mm)	Price (€)
alcera P15 K05	1500	547,6,-
alcera P20 K05	2000	604,9,-



Order code	Width (mm)	Price (€)
alcera P15 K06	1500	615,0,-
alcera P20 K06	2000	672,2,-



Order code	Width (mm)	Price (€)
alcera P15 K07	1500	787,4,-
alcera P20 K07	2000	844,7,-



Order code	Width (mm)	Price (€)
alcera P15 K08	1500	855,4,-
alcera P20 K08	2000	912,8,-



Order code	Width (mm)	Price (€)
alcera U15 K08	1500	805,8,-
alcera U20 K08	2000	863,1,-



Order code	Width (mm)	Price (€)
alcera U15 K09	1500	854,8,-
alcera U20 K09	2000	912,1,-



Order code	Width (mm)	Price (€)
alcera U15 K10	1500	1054,8,-
alcera U20 K10	2000	1112,1,-



Order code	Width (mm)	Price (€)
alcera U15 K11	1500	1152,8,-
alcera U20 K11	2000	1210,1,-



Order code	Width (mm)	Price (€)
alcera P15 K09	1500	851,4,-
alcera P20 K09	2000	908,7,-



Order code	Width (mm)	Price (€)
alcera P15 K10	1500	1023,9,-
alcera P20 K10	2000	1081,1,-



Order code	Width (mm)	Price (€)
alcera P15 K11	1500	1399,8,-
alcera P20 K11	2000	1457,0,-



Order code	Width (mm)	Price (€)
alcera P15 K12	1500	1368,4,-
alcera P20 K12	2000	1425,8,-

Wrapping workbench

workbench is furnished with adjustable feet, a cutter with a holder of cutting material and a cutting cartridge with a blade knife. Unrolling bar with centering cones can be placed above or under the work desk. The upper extension of the workbench is furnished with a shelf with vertical bars.



Order code	description	Width (mm)	Price (€)
alcera UBS K01	with a cabinet	2350	1540,3,-
alcera UBS Z01	without a cabinet	2000	1246,1,-

Antistatic workbench

workbench is furnished with adjustable reinforced feet, an ESD work desk with an earthing cable and an ESD earthing box ESD P2BA, an energy channel, an upper extension with EUROPERFO fillings, 200 mm deep hinged shelves, ESD pads with earthing cables, an illuminating ramp with a light P236 and a hanging C-profile with a trolley with four castors.



Order code	Width (mm)	Price (€)
alcera U15E K11	1500	1794,8,-

Upper extensions of workbenches

If our versions of upper extensions do not meet your requirements, you can design your own version made of components which you will find in section Individual programme for ALCERA and ALPEDE workbenches.



Order code	Width (mm)	Price (€)
SDEP 15 10U K1	1500	150,4,-
SDEP 20 10U K1	2000	173,5,-

beams 10U, EUROPERFO® panels 10U

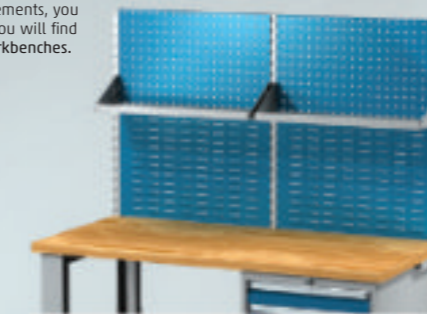

Order code	Width (mm)	Price (€)
SDEP 15 20U K1	1500	371,0,-
SDEP 20 20U K1	2000	444,6,-

beams 20U, EUROPERFO® panels, EUROBOX® panels, 200 mm hinged shelves



Order code	Width (mm)	Price (€)
SDEP 15 25U K1	1500	800,7,-
SDEP 20 25U K1	2000	896,3,-

beams 25U, energy channel, EUROPERFO® panels, EUROBOX® panels, 200 mm hinged shelves, beam with light P236



Drawer cabinets PROFI

dimensional line	2727E	3627E	4527E	5427E
	3636E	4536E	5436E	

Drawer cabinets UNI

Workshop trolleys

Workbenches

ALCERA	ALPEDE
ALSOR	ALNAK

Workshop cabinets

system	universal
warehouse	

Perfo systems

mobile
stationary

Holders for tools

Plastic bins

Computer cabinets

Fire extinguishers

Surface treatment

alpede UNI

Workbenches alpede UNI - standard versions

Technical parametres:

- The workdesk is made of 40 mm waterproof glued beech chipboard.
- Massive base on feet or pallet base for easy moving using common handling device.
- The height of the work surface is 880 mm.
- UNI cabinets 13U with lockable doors and shelves of surface max. load 40 kg, shelves are adjustable after 25 mm.
- The UNI cabinets 13U with 100% telescopic drawers, drawer's surface max. load 40 kg, central locking, an aluminium handle with a groove for inserting a label with drawer's contents, drawers perforated on their sides and bottoms for using metal dividing bars in transverse direction.



Order code alpede UN15 K01 Price (€) 1093,1,-



Order code alpede UN15 K02 Price (€) 1191,1,-



Order code alpede UN15 K03 Price (€) 1515,4,-



Order code alpede UN15 K04 Price (€) 1562,6,-



Order code alpede UN20 K01 Price (€) 1585,1,-



Order code alpede UN20 K02 Price (€) 1781,1,-



Order code alpede UN20 K03 Price (€) 2103,6,-



Order code alpede UN20 K04 Price (€) 2103,6,-



Order code alpede UP15 K01 Price (€) 1115,7,-



Order code alpede UP15 K02 Price (€) 1213,6,-



Order code alpede UP15 K03 Price (€) 1536,1,-



Order code alpede UP15 K04 Price (€) 1585,1,-



Order code alpede UP20 K01 Price (€) 1618,0,-



Order code alpede UP20 K02 Price (€) 1814,0,-



Order code alpede UP20 K03 Price (€) 2136,5,-



Order code alpede UP20 K04 Price (€) 2136,5,-

Workbench alpede PROFI - standard versions

Technical parametres:

- The workdesk is made of 40 mm waterproof glued beech chipboard.
- Massive base on feet or pallet base for easy moving using common handling device.
- The height of the work surface is 880 mm.
- PROFI cabinets 13U with lockable doors and handles and shelves of surface max. load 50 kg, shelves are adjustable after 25 mm.
- The PROFI cabinets 13U with 80% telescopic drawers, drawer's surface max. load 90 kg, central locking with a blocation of opening several drawers together, an aluminium handle with a groove for inserting a label with drawer's contents, drawers perforated on their sides for using metal dividing bars.
- Cabinets with 100% telescopic drawers and max. load 65 or 180 kg can be ordered for an extra charge.



Order code alpede PN15 K01 Price (€) 1059,6,-



Order code alpede PN15 K02 Price (€) 1127,6,-



Order code alpede PN15 K03 Price (€) 1014,7,-



Order code alpede PN15 K04 Price (€) 1377,3,-



Order code alpede PN20 K01 Price (€) 1432,4,-



Order code alpede PN20 K02 Price (€) 1500,4,-



Order code alpede PN20 K03 Price (€) 1489,9,-



Order code alpede PN20 K04 Price (€) 1999,8,-



Order code alpede PP15 K01 Price (€) 1079,2,-



Order code alpede PP15 K02 Price (€) 1147,2,-



Order code alpede PP15 K03 Price (€) 1034,3,-



Order code alpede PP15 K04 Price (€) 1396,9,-



Order code alpede PP20 K01 Price (€) 1461,0,-



Order code alpede PP20 K02 Price (€) 1529,0,-



Order code alpede PP20 K03 Price (€) 1518,5,-



Order code alpede PP20 K04 Price (€) 2028,4,-



Order code alpede PK12 K01 Price (€) 942,1,-



Order code alpede PK12 K02 Price (€) 1191,9,-



Order code alpede PK12 K03 Price (€) 1146,9,-



Order code alpede PK12 K04 Price (€) 1509,6,-

alpede PROFI

alsor Individual programme of components for ALSOR workbenches



Basic workbench ALSOR

- Range of manual height settings of the work surface 681 - 1037 mm.
- The colour of the frame is RAL 7035 or RAL 7016, inner profiles of feet are coated with blue zinc chromate.
- The frame is made of 40 x 40 mm steel profiles, inner profiles of feet are 35 x 35 mm.
- The max. load of workbench is 400 kg.
- Work desk - 25 mm light grey laminated chipboard, light or dark grey ABS edge.



Order code	Width (mm)	Price (€)
DPL 120 Z S	1200	446,2,-
DPL 150 Z S	1500	486,4,-
DPL 200 Z S	2000	557,0,-

ESD workbench ALSOR

- Range of manual height settings of the work surface 681 - 1037 mm.
- The colour of the frame is RAL 7035 or RAL 7016, inner profiles of feet are coated with blue zinc chromate.
- The frame is made of 40 x 40 mm steel profiles, inner profiles of feet are 35 x 35 mm.
- The max. load of workbench is 400 kg.
- 27 mm ESD workdesk, light or dark grey ABS edge, earthing cable and earthing box A.
- For an extra charge the frame can be painted with ESD colour.



Order code	Width (mm)	Price (€)
DPL 120 Z ESD	1200	635,8,-
DPL 150 Z ESD	1500	692,2,-
DPL 200 Z ESD	2000	797,0,-

Lower deposit shelf

The shelf is made of light grey 25 mm laminated chipboard with ABS edge in light or dark grey. The shelf is reinforced with a steel profile, its max. load is 30 kg.



Order code	Width (mm)	Price (€)
DL POL 300 1140 S	1140	68,6,-
DL POL 300 1440 S	1440	86,5,-
DL POL 300 1940 S	1940	116,5,-

Extensional workbench ALSOR

- Dimensions of work surface are 1200 x 500 mm.
- Range of manual height settings of the work surface 681 - 1037 mm.
- The colour of the frame is RAL 7035 or RAL 7016, inner profiles of feet are coated with blue zinc chromate.
- The frame is made of 40 x 40 mm steel profiles, inner profiles of feet are 35 x 35 mm.
- The max. load of workbench is 400 kg.
- Workdesk - 25 mm light grey laminated chipboard, light or dark grey ABS edge.



Order code	Price (€)
DPL 120 P50 S	370,8,-

Extensional ESD workbench ALSOR

- Dimensions of work surface are 1200 x 500 mm.
- Range of manual height settings of the work surface 681 - 1037 mm.
- The colour of the frame is RAL 7035 or RAL 7016, inner profiles of feet are coated with blue zinc chromate.
- The frame is made of 40 x 40 mm steel profiles, inner profiles of feet are 35 x 35 mm.
- The max. load of workbench is 400 kg.
- 27 mm ESD work desk, light or dark grey ABS edge, earthing cable and earthing box A.
- For an extra charge the frame can be painted with ESD colour.



Order code	Price (€)
DPL 120 P50 ESD	554,7,-

1



1 Components for upper extension

Holder of EUROPERFO® panels and accessories
Stable system holder of upper extension incl. adapters for connecting to the frame of the workbench. The holders are produced in two versions - for upper extension with max. load of 15 or 30 kg. Available colours RAL 7035 or 7016.

Order code	height (mm)	upper extension max. load (kg)	Price (€)
DL DEP 10U S	459	15	23,8,-
DL DEP 15U S	681	15	30,6,-
DL DEP 20U S	903	15	33,3,-
DL DEP 25U S	1125	15	37,4,-
DL DEP 30U S	1305	15	41,8,-
DL DEP 10U B	459	30	31,9,-
DL DEP 15U B	681	30	45,1,-
DL DEP 20U B	903	30	57,6,-
DL DEP 25U B	1125	30	68,5,-
DL DEP 30U B	1305	30	78,4,-

Shelf for upper extension
The shelf is 300 mm deep and its max. load is 15 kg. Beams and reinforcing element are available in RAL 7035 or RAL 7016.

The desk of the standard version is made of light grey laminated chipboard with ABS edge in light or dark grey. 27 mm ESD workdesk, dark grey ABS edge and earthing cable.



Order code	Length (mm)	Price (€)
DL POL 300 1200 H	1200	85,4,-
DL POL 300 1500 H	1500	103,4,-
DL POL 300 2000 H	2000	133,4,-
DL POL 300 1200 H ESD	1200	145,1,-
DL POL 300 1500 H ESD	1500	176,3,-
DL POL 300 2000 H ESD	2000	228,3,-

EUROPERFO® panels
The profiled sheet board is intended for mounting to the EUROPERFO holders. The perforation for placing of the holders for tools of the DEP line is made through square slots 10 x 10 mm, spacing is 38 mm. Available colours RAL 7035 or 7016.



Order code	Dimensions h x w (mm)	Price (€)
DL EP 5U 1140	222 x 1140	38,0,-
DL EP 5U 1440	222 x 1440	43,7,-
DL EP 5U 1940	222 x 1940	56,6,-

Beam of illuminating body
Beams made of steel profiles furnished with a holder of illuminating body, forstanding 530 mm.



Order code	Length (mm)	Price (€)
DL DZA 1500	1500	60,8,-
DL DZA 2000	2000	64,0,-

Order code	Info	Price (€)
P136 AC E 1x36W EVG	one-tube body without a source	80,2,-
P236 AC E 2x36W EVG	two-tube body without a source	100,0,-
	toggle switch for EVG lamps	11,4,-
ALMAX 236E	two-tube aluminium body without a source	241,3,-

Combined moulding for hanging of bins

The profiled moulding designed for hanging of plastic bins of the SB line, the moulding is intended for mounting to the EUROPERFO holders. Its middle part is perforated with slots 10 x 10 mm and with 38 mm spacing which enables installation of the DEP holders of tools. Available colours RAL 7035 or 7016.



Order code	Dimensions h x w (mm)	Price (€)
DL EPZ 1140	139 x 1140	40,2,-
DL EPZ 1440	139 x 1440	46,6,-
DL EPZ 1940	139 x 1940	60,2,-

2

Accessories for mounting on sides

Holder of monitor and keyboard
Joint holder of VESA 75 system for keyboard, mouse and monitor up to 23".



Order code	Price (€)
PCD KM	84,7,-

Shelf

Joint holder with a hinged shelf, dim. 222 x 444 mm, max. load of the shelf is 10 kg.



Order code	Price (€)
DL POL B S	60,2,-

EUROPERFO® panel

Joint holder with EUROPERFO® panel for DEP system holders for tools. Dimensions 444 x 444 mm, max. load 10 kg.

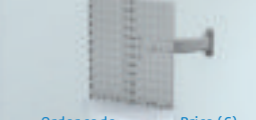

Order code	Price (€)
DL EP B S	53,9,-

EUROBOX® panel

Joint holder with EUROBOX® panel for plastic bins. Dim. 444 x 444 mm, max. load 10 kg.



Order code	Price (€)
DL EB B S	55,7,-

3

Holder of computer

Holder is designed for installation of a computer max. 187 mm wide and 450 mm high.

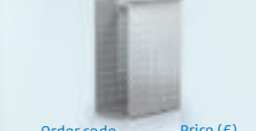

Order code	Price (€)
PCD V1	50,7,-

Hanging C-profile for tools

C-profile for installation on beams of holders of illuminating body. The profile can be furnished with trolley with two or four castors, max. load is 15 kg.



Order code	Length (mm)	Price (€)
DL CZP 1500	1500	24,1,-
DL CZP 2000	2000	26,9,-

Order code	Info	Price (€)
DP DZS 2V	trolley with two castors	17,0,-
DP DZS 4V	trolley with four castors	28,2,-



Drawer cabinets PROFI

dimensional line	2727E	3627E	4527E	5427E
	3636E	4536E	5436E	

Drawer cabinets UNI

Workshop trolleys

Workbenches

ALCERA	ALPEDE
ALSOR	ALNAK

Workshop cabinets

system	universal
warehouse	

Perfo systems

mobile
stationary

Holders for tools

Plastic bins

Computer cabinets

Fire extinguishers

Surface treatment

alsor UNI

Workbenches alsor UNI - standard versions

Technical parametres:

- Work desk made of grey laminated chipboard with dark grey ABS edge.
- Massive frame made of foursquare profiles, surface max. load of work surface is 400 kg.
- Range of manual height settings of the work surface is 681 - 1037 mm.
- The UNI hanging cabinets with 100% telescopic drawers, drawer's surface max. load 40 kg, central locking, an aluminium handle with a groove for inserting a label with drawer's contents, drawers perforated on their sides and bottoms for using metal dividing bars in transverse direction.
- ESD versions of ALCERA workbenches can be ordered for the below given extra charge.



Order code	Width (mm)	Price (€)
alsor U12 K01	1200	576,1,-
alsor U15 K01	1500	616,3,-
alsor U20 K01	2000	686,9,-



Order code	Width (mm)	Price (€)
alsor U12 K02	1200	730,2,-
alsor U15 K02	1500	770,4,-
alsor U20 K02	2000	840,9,-



Order code	Width (mm)	Price (€)
alsor U12 K03	1200	730,2,-
alsor U15 K03	1500	770,4,-
alsor U20 K03	2000	840,9,-



Order code	Width (mm)	Price (€)
alsor U12 K04	1200	779,1,-
alsor U15 K04	1500	819,3,-
alsor U20 K04	2000	889,9,-



Order code	Price (€)
DPL 50 P	520,4,-



Length of workbench (mm)	Extra charge (€)
1200	189,6,-
1500	205,8,-
2000	240,1,-

The ESD set consists of a 27 mm high antistatic pad, a snap button, an earthing cable and an ESD earthing box A.

alsor PROFI

Workbenches alsor PROFI - standard versions

Technical parametres:

- Work desk made of grey laminated chipboard with light or dark grey ABS edge.
- Massive frame made of foursquare profiles, surface max. load of work surface is 400 kg.
- Range of manual height settings of the work surface is 681 - 1037 mm.
- The PROFI hanging cabinets with 80% telescopic drawers, drawer's surface max. load 90 kg, central locking with a blocation of opening several drawers together, an aluminium handle with a groove for inserting a label with drawer's contents, drawers perforated on their sides for using metal dividing bars.
- Cabinets with 100% telescopic drawers and max. load 65 or 180 kg can be ordered for an extra charge.



Order code	Width (mm)	Price (€)
alsor P12 K01	1200	652,0,-
alsor P15 K01	1500	692,2,-
alsor P20 K01	2000	762,8,-



Order code	Width (mm)	Price (€)
alsor P12 K02	1200	828,8,-
alsor P15 K02	1500	869,1,-
alsor P20 K02	2000	939,6,-



Order code	Width (mm)	Price (€)
alsor P12 K03	1200	896,9,-
alsor P15 K03	1500	937,1,-
alsor P20 K03	2000	1007,7,-



Order code	Width (mm)	Price (€)
alsor P12 K04	1200	970,1,-
alsor P15 K04	1500	1010,3,-
alsor P20 K04	2000	1080,8,-

Upper extensions of workbenches

Max. load of upper extension is 30 kg

If our versions of upper extensions do not meet your requirements, you can design your own version made of components which you will find in section Individual programme for ALSOR workbenches.



Order code	Width (mm)	Price (€)
SDEL 12 10U K1	1200	142,0,-
SDEL 15 10U K1	1500	154,1,-
SDEL 20 10U K1	2000	180,6,-

reinforced beams 10U, EUROPERFO® panel, combined moulding for plastic bins



Order code	Width (mm)	Price (€)
SDEL 12 20U K1	1200	316,8,-
SDEL 15 20U K1	1500	352,7,-
SDEL 20 20U K1	2000	422,0,-

reinforced beams 20U, 2x EUROPERFO® panel, combined moulding for plastic bins, shelf



Order code	Width (mm)	Price (€)
SDEL 15 25U K1	1500	955,1,-
SDEL 20 25U K1	2000	1036,7,-

reinforced beams 25U, energy channel, EUROPERFO® panel, combined moulding for plastic bins, shelf, beam with light ALMAX, hanging system with trolley with four castors



Electrically controlled workbenches ALNAK

Technical parameters:

- Work desk made of laminated chipboard with ABS edge made of materials according to chart.
- Range of height settings of the work surface is 660 - 1310 mm, speed 38 mm/s.
- Max. load of workbench is 200 kg.
- Colour of the metal frame is silver or black.



birch beech alder cherry hazel grey with anthracite



Remote control AL-H
Switchboard with two buttons for height settings of work surface, extra charge equipment of ALNAK workbenches. Extra charge 11,7,- €.



Remote control AL-A
Switchboard with two buttons for height settings of work surface, standard equipment of ALNAK workbenches.



Remote control AL-F1C
Controlling switchboard with a display showing actual height and a memory for three positions, diagnostic functions, extra charge equipment of ALNAK workbenches. Extra charge 93,1,- €.



Order code	Width (mm)	Price (€)
alnak 12 K01	1200	1857,1,-
alnak 15 K01	1500	1891,5,-
alnak 20 K01	2000	1945,2,-



Order code	Width (mm)	Price (€)
alnak 12 K02	1200	1915,4,-
alnak 15 K02	1500	1955,6,-
alnak 20 K02	2000	2022,2,-

Back covering sheet 5U = 222 mm



Order code	Width (mm)	Price (€)
alnak 12 K03	1200	2102,6,-
alnak 15 K03	1500	2166,6,-
alnak 20 K03	2000	2276,0,-

Beams 10U H459 mm with assembly slots, spacing 22 mm, back covering sheet, EUROPERFO® panel 5U, shelf 300 mm.



Order code	Width (mm)	Price (€)
alnak 15 K04	1500	3019,0,-

Beams 20U H903 mm with assembly slots, spacing 22 mm, back covering sheet, 3x EUROPERFO® panel 5U, shelf 300 mm, energy channel K1, illuminating body holder, lamp ALMAX.



Order code	Width (mm)	Price (€)
alnak 15 K05	2000	3347,9,-

Width of upper extension is 1500 mm, beams 20U H903 mm with assembly slots, spacing 22 mm, back covering sheet, 3x EUROPERFO® panel 5U, shelf 300 mm, energy channel K1, illuminating body holder, lamp ALMAX, cabinet DKU 6U 2AS.



Order code	Width (mm)	Price (€)
alnak 15 K06	2000	2284,6,-

Back covering sheet, cabinet DKU 6U 2AS.

Vertical system cupboards



The vertical system cupboards are designed for storing tools and material at warehouses and production workplaces. The cupboards furnished with ejecting systems of the DSV line allow to their users an easy access to objects stored in their whole depth of the deposit space. A wide range of accessories and additional equipment will help you to maintain the system and order in the stored items. The bodies of the DSV cupboards has carrying capacity 800 kg. The bottom part of the body is furnished with a height adjustment. In the bottom and back walls there are slots for anchoring to build constructions. The cupboards are locked centrally with an inbuilt safety system which blocks ejecting of several frames at the same time. In case that the cupboards are weighted equally it makes a protection against overturning. The ejecting frames are guided in massive slide rails Fullterer which do not need any maintenance. In our offer there are frames in version A with carrying capacity 60 kg and frames in version B with carrying capacity 180 kg. In the frontal side there is placed a massive aluminium handle. Its outer part is modified to allow inserting a label with drawer's contents. The frame's construction is prepared for mounting of accessories. We can design and produce accessories intended for mounting into the ejecting frames of the DSV cupboards according to customer's specification. The holders of components of the Trumpf tool system are also available.

Damped closing

Order code	Price (€)
TSV 181	69,4,-

The ejecting frames of the DSV cupboards in version B with carrying capacity 180 kg can be furnished (for the below given extra charge) with a system of damped closing. The given price is for furnishing of one ejecting frame.



Order code	Version	Price (€)
DSV CNC A2	2	28,9,-
DSV CNC A3	3	25,7,-
DSV CNC A4	4	21,9,-

The adapters are intended for mounting into supporting frames of the DSV line cupboards. They are available for all the dimensional versions of the DSV cupboards. The given price is for a pair incl. hardware.

Order code	Price (€)
DSV CNC N52	51,6,-
DSV CNC N82	58,8,-
DSV CNC N102	64,0,-

The CNC carriers represent a basic manipulation element which is intended for installation of plastic bins for storing tools. Each carrier is on its both sides furnished with aluminium handles with safety pin which ensures carrier's safe fixation in the ejecting frame. The carriers are available for boxes of sizes 52, 82 and 102 mm. The CNC boxes you will find on page 89 of this catalogue.



Order code	Frame carrying capacity (kg)	Price (€)
DSV 92 1 2A	60	1211,0,-
DSV 92 1 2B	180	1594,3,-

Order code	Frame carrying capacity (kg)	Price (€)
DSV 92 1 3A	60	1555,6,-
DSV 92 1 3B	180	2151,0,-

Order code	Frame carrying capacity (kg)	Price (€)
DSV 92 1 4A	60	1886,6,-
DSV 92 1 4B	180	2680,4,-

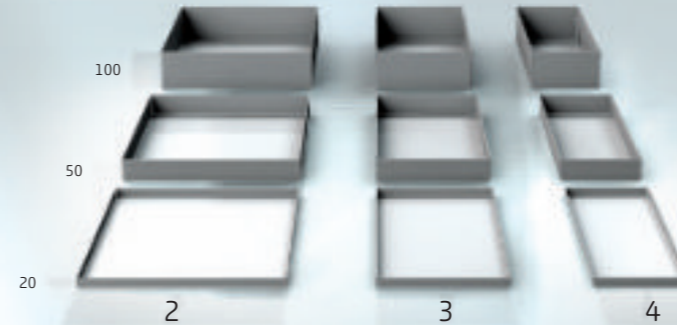

Order code	Version	Height (mm)	Price (€)
DSV P2 2	2	20	18,1,-
DSV P2 5	2	50	20,3,-
DSV P2 10	2	100	22,7,-
DSV P3 2	3	20	16,2,-
DSV P3 5	3	50	18,2,-
DSV P3 10	3	100	20,4,-
DSV P4 2	4	20	14,6,-
DSV P4 5	4	50	16,4,-
DSV P4 10	4	100	18,4,-

The shelves, which are intended for mounting into ejecting frames of the DSV cupboards, are produced in three height versions with edge's height 20, 50 and 100 mm. They are available for all the dimensional versions of the DSV cupboards. The supply includes holders to be mounted into the frame. The shelves can be adjusted after 25 mm.

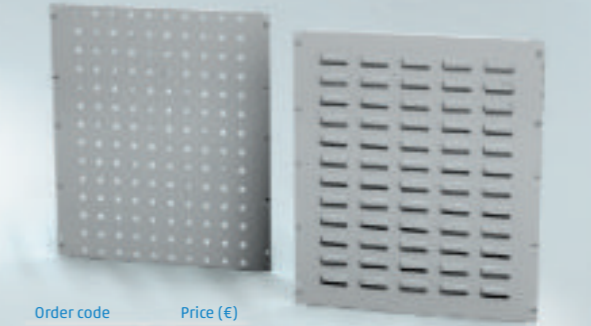

Order code	Price (€)
DSV EP A	37,1,-

The EUROPERFO panel dim. 522 x 466 x 10 mm is to be mounted into the supporting part of the ejecting frame of the DSV cupboards. The panels are intended for mounting holders for the DEP line tools. For installation along the whole height of the frame 3 panels are needed.

Order code	Price (€)
DSV EB A	47,2,-

The ALFABOX panel dim. 522 x 466 x 13 mm is to be mounted into the supporting part of the ejecting frame of the DSV cupboards. The panels are intended for fitting the plastic bins of the SB line up to the size 2. For installation along the whole height of the frame 3 panels are needed.

Workshop cupboards

System cupboards PROFI

page 66 - 71

Cupboard's depth 600mm.

The system cupboards of the DSP line represent a professional solution for storing materials and tools at industry and service plants. They are designed for high weighting of shelves, drawers and ejecting systems.

In our assortment you can find a wide range of standard versions or in the individual programme section you can set your own cupboard furnished according to your demands.

- The body is characterized by a solid welded construction and it is furnished with a height adjustment and with slots for anchoring to the floor or to the wall. The body's carrying capacity is 400 - 800 kg. The body is inside prepared for installation of shelves or supporting construction for installation of drawers.
- EUROPERFO* the inner part of doors is perforated in order to mount holders for tools. For an extra charge we can supply a perforated upper part of cupboard's back wall.
- ALFABOX* for an extra charge you can order bodies which are in their upper half of the back wall and in the upper part pressed in order to mount plastic bins.
- The doors are hinged on massive pivots, angle of opening is 110°. On their inner part there is a reinforcing element. Locking is solved by a turning padlock cap and a three-point locking mechanism. Alternatively you can order cupboards with glass-filled doors.
- The shelves have a surface carrying capacity 100 kg and are adjustable after 25 mm.
- The drawers in 4527 E version we offer in five heights. Versions with carrying capacity 65 , 100 or 180 kg and sliding 80 or 100% are also available.
- The CNC ejecting frames are intended for installation of carriers for CNC tools. Their parameters are the same as for drawers.
- Damped closing can be ordered for an extra charge. It is a comfort device for drawers or for CNC ejecting frames.
- The blocation of opening several drawers makes a protection against cupboard's overturning when several heavily weighted drawers are opened at the same time. This system is for an extra charge. As the first producer we offer this system for cupboards with wing doors.

Cupboards UNI

page 72 - 75

Cupboard's depth 500mm.

The cupboards of the DSU line represent a price-friendly solution for storing materials and tools at industry plants. They are designed for average level of weighting of shelves and drawers.

Among the cupboards DSU there are a lot of standard versions concerning both common versions of workshop cupboards and cupboards for tools incl. versions furnished with a writing desk.

- The body is characterized by a solid welded construction and it is furnished with slots for anchoring to the floor or to the wall. The body's carrying capacity is 200 - 600 kg. The body is inside prepared for installation of shelves or supporting construction for installation of drawers.
- EUROPERFO* the inner part of doors is perforated in order to mount holders for tools. For an extra charge we can supply a perforated upper part of cupboard's back wall.
- The doors are hinged on massive pivots, angle of opening is 110°. On their inner part there is a reinforcing element. Locking is solved by a turning padlock cap and a three-point locking mechanism.
- The shelves have a surface carrying capacity 80 kg and are adjustable after 25 mm.
- The drawers in 4623 E and 2223 E version are offered in five heights. Their surface carrying capacity is 40 kg, sliding is 100%. Into the drawers there can be mounted divider sets to divide it transversally.

Universal cupboards US

page 76 - 79

Cupboard's depth 400mm.

The universal cupboards US represent a price-friendly solution for storing of materials, tools, documents and office equipment at production plants, warehouses, offices and archives.

The cupboards US are offered in many dimensional versions. Their modular dimensional construction allows connecting them together or with additional cupboards and creating then variable cupboard's walls. Besides the basic cupboards with drawers in our assortment you can also find versions for storing chemicals and small parts, showcases, versions with lockable boxes and versions with ejecting systems for hanging files.

- The body is characterized by a solid welded construction and it is furnished with slots for anchoring to the wall. The body's carrying capacity is 100 - 300 kg. The body is inside prepared for installation of shelves.
- The doors are hinged on massive pivots, angle of opening is 110°. On their inner part there is a reinforcing element. Locking is solved by a turning padlock cap and a three-point locking mechanism.
- The shelves have a surface carrying capacity 60 kg and are adjustable after 25 mm.

Warehouse cupboards SS, US

page 80 - 81

Cupboard's depth 200, 300, 400mm.

The warehouse cupboards of the SS and US line are designed for storing small pieces and materials at production or assembly plants and warehouses.

The warehouse cupboards are offered in many dimensional versions. Versions without doors or versions intended for mounting on the wall are also available.

- The body is characterized by a solid welded construction and it is furnished with slots for anchoring to the wall. The body's carrying capacity is 100 - 300 kg. The body is inside prepared for installation of shelves.
- The doors are hinged on massive pivots, angle of opening is 110°. On their inner part there is a reinforcing element. Locking is solved by a turning padlock cap and a three-point locking mechanism.
- The shelves have a surface carrying capacity 60 kg and are adjustable after 25 mm.





Drawer cabinets PROFI

dimensional line	2727E	3627E	4527E	5427E
	3636E	4536E	5436E	

Drawer cabinets UNI

Workshop trolleys

Workbenches

ALCERA	ALPEDE
ALSOR	ALNAK

Workshop cabinets

system	universal
warehouse	

Perfo systems

mobile
stationary

Holders for tools

Plastic bins

Computer cabinets

Fire extinguishers

Surface treatment

System cupboards PROFI

Individual programme, accessories

Body with full doors

The body of the DSP line universal cupboard. The wing doors are hinged on massive metal pivots with opening option of 100° angle. The door's internal part are perforated in EUROPERFO system. The inner space of cupboards can be further furnished with shelves or drawers fitted in supporting construction. The body of the low cupboard is furnished with a putting surface with a frame and a foam filling.



Order code	Dimensions (mm)	Carrying capacity (kg)	Price (€)
DSP 92 1 K P	1950 x 920 x 600	800	389,9,-
DSP 92 3 K P	1170 x 920 x 600	400	292,4,-

Body with glass-filled doors

The body of the DSP line universal cupboard. The wing doors are hinged on massive metal pivots with opening option of 100° angle. The doors are filled with safety hardened glass. The inner space of cupboards can be further furnished with shelves or drawers fitted in supporting construction. The body of the low cupboard is furnished with a putting surface with a frame and a foam filling.



Order code	Dimensions (mm)	Carrying capacity (kg)	Price (€)
DSP 92 1 K S	1950 x 920 x 600	800	491,9,-
DSP 92 3 K S	1170 x 920 x 600	400	368,9,-

EUROPERFO® modification of body

EUROPERFO modification of the upper half of the inner part of the DSP 92 1 K body is made for installation of system holders for tools.



Order code	Price (€)
DSP 92 1 EPV	44,1,-

ALFABOX® modification of body

ALFABOX modification of doors and of the upper half of the inner part of the DSP 92 1 K body is made for installation of plastic bins and system holder of tools.

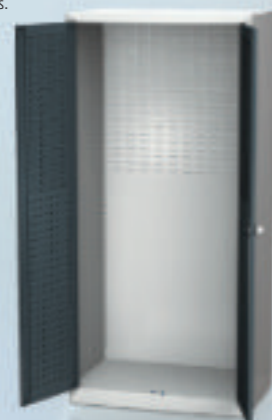

Order code	Price (€)
DSP 92 1 EB1	66,1,-

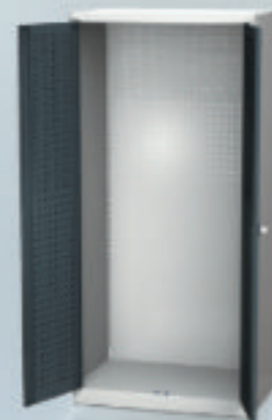

Order code	Price (€)
DSP 92 1 EB2	59,6,-

Covering panel of EUROPERFO slots

If you need the EUROPERFO slots can be covered by a panel (for an extra charge) which has to be fitted from the outer side on the rear part of the body. The panel protects against dust and dirt going in through the slots.

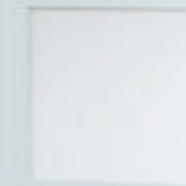

Order code	Price (€)
DSP 92 1 KEP	35,5,-

Supporting construction for drawers installation

In case of drawers installation it is necessary to choose a supporting construction in the corresponding size. The supporting construction is modified for optional installation of damped closing.



Order code	Height (mm)	Price (€)
DSP 92 PK 8U	372	76,6,-
DSP 92 PK 21U	950	130,6,-
DSP 92 PK 40U	1868	164,0,-

* The price includes a dividing shelf.

Basic shelf

The reinforced shelf with surface carrying capacity 100 kg incl. 4 pcs of holders to be mounted into the body. The shelves are adjustable after 25 mm.



Order code	Price (€)
PO DSP 92 A1	34,3,-



Order code	Price (€)
PO DSP 92 A2	33,7,-

Shelf for supporting construction mounting

The reinforced shelf with surface carrying capacity 100 kg incl. 4 pcs of holders to be mounted into the body. The shelf's dimensions are adapted for mounting to the supporting construction for drawers installation. The shelves are adjustable after 25 mm.

Blockage of opening several drawers together

For an extra charge you can order a safety system which blocks opening of several drawers at the same time. It is a protection against overturning of the product.



Order code	Height (mm)	Price (€)
DSP BVZ 8U	372	71,7,-
DSP BVZ 21U	950	96,6,-
DSP BVZ 40U	1868	127,4,-

Pallet base

For an extra charge the cupboards can be placed on a pallet base which makes the cupboard's manipulation easier. In case of using it in combination with a cupboard with ejecting systems we recommend anchoring the cupboard to the wall. Alternatively you can use the DSP BVZ system. This system decreases the risk of cupboard's overturning because it blocks opening of more drawers at the same time.



Order code	Price (€)
DSP PMP 92	98,8,-

Damped closing of drawers

For an extra charge the drawers of the DSP line cupboards can be furnished with a system of damped closing. This system is intended for drawers with maximum weighting up to 70 kg. A high quality gas damper ensures secure running and a long lifetime of the system.



Order code	Price (€)
TSI 80	35,9,-

Individual programme, accessories

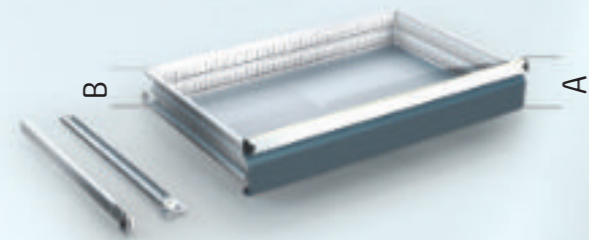

Drawers 4527E, sliding 80%, carrying capacity 90 kg

Order code	Front's height	Side's height	Price (€)
DKP Z 4527 2U A	85	58	92,6,-
DKP Z 4527 3U A	129	102	100,3,-
DKP Z 4527 4U A	174	147	108,0,-
DKP Z 4527 5U A	218	191	115,8,-
DKP Z 4527 6U A	263	236	123,5,-
	A	B	

The drawers are guided in massive slide-rails Fullterer with four ball bearings. These slide-rails are characteristic by an easy and silent running.

The drawers are furnished with a comfort aluminium handle with an installed holder of a safety pin DKP PVZ and with a groove for a label with drawer's contents.

The inner parts of the drawers are pressed and grooved for installing of metal divider sets. Groove spacing is 1E = 17 mm. Useable drawer plan is 757 x 451 mm.



Divider sets for drawers

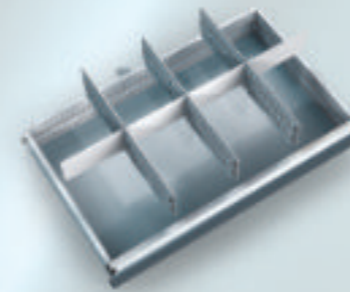

Order code	Price (€)
DMZ 4527 2U 8P	31,6,-
DMZ 4527 3U 8P	45,1,-
DMZ 4527 5U 8P	61,3,-

The divider set of the 45E x 27E drawers allows dividing the drawer's inner part into 8 pieces. It contains 3x perforated dividing bar 27E, 3x bar 12E and 1x bar 9E.

The 3U divider set is intended for drawers 3U and 4U, the 5U divider set is intended for drawers 5U and 6U.

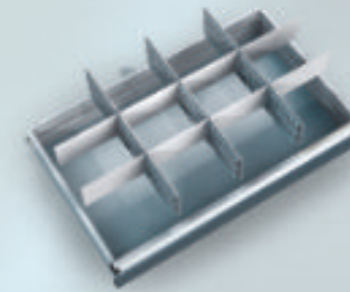

Order code	Price (€)
DMZ 4527 2U 12P	38,5,-
DMZ 4527 3U 12P	55,8,-
DMZ 4527 5U 12P	79,7,-

The divider set of the 45E x 27E drawers allows dividing the drawer's inner part into 12 pieces. It contains 3x perforated dividing bar 27E, 6x bar 12E and 2x bar 9E.

The 3U divider set is intended for drawers 3U and 4U, the 5U divider set is intended for drawers 5U and 6U.

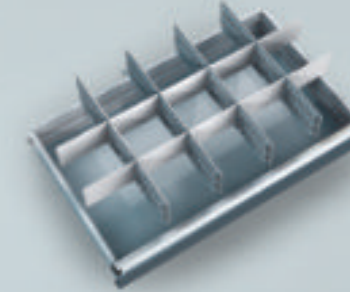

Order code	Price (€)
DMZ 4527 2U 15P	46,6,-
DMZ 4527 3U 15P	67,5,-
DMZ 4527 5U 15P	94,5,-

The divider set of the 45E x 27E drawers allows dividing the drawer's inner part into 15 pieces. It contains 4x perforated dividing bar 27E and 10x bar 9E.

The 3U divider set is intended for drawers 3U and 4U, the 5U divider set is intended for drawers 5U and 6U.



Drawers 4527E, sliding 100%, carrying capacity 65 kg

Order code	Front's height	Side's height	Price (€)
DKP Z 4527 2U B	85	58	123,9,-
DKP Z 4527 3U B	129	102	131,6,-
DKP Z 4527 4U B	174	147	139,4,-
DKP Z 4527 5U B	218	191	147,0,-
DKP Z 4527 6U B	263	236	154,8,-
	A	B	

The drawers are guided in massive slide-rails Fullterer with ten pulleys. These slide-rails are characteristic by an easy and silent running.

The drawers are furnished with a comfort aluminium handle with an installed holder of a safety pin DKP PVZ and with a groove for a label with drawer's contents.

The inner parts of the drawers are pressed and grooved for installing of metal divider sets. Groove spacing is 1E = 17 mm. Useable drawer plan is 757 x 451 mm.

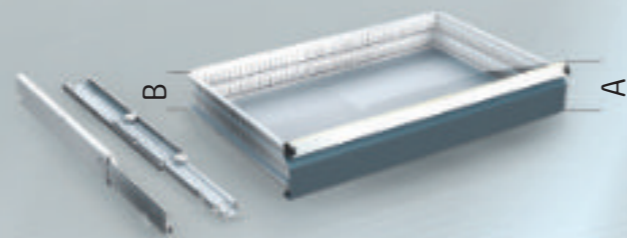

Drawers 4527E, sliding 100%, carrying capacity 180 kg

Order code	Front's height	Side's height	Price (€)
DKP Z 4527 3U C	129	102	172,7,-
DKP Z 4527 4U C	174	147	180,5,-
DKP Z 4527 5U C	218	191	188,2,-
DKP Z 4527 6U C	263	236	195,9,-
	A	B	

The drawers are guided in massive slide-rails Fullterer with ten pulleys. These slide-rails are characteristic by an easy and silent running.

The drawers are furnished with a comfort aluminium handle with an installed holder of a safety pin DKP PVZ and with a groove for a label with drawer's contents.

The inner parts of the drawers are pressed and grooved for installing of metal divider sets. Groove spacing is 1E = 17 mm. Useable drawer plan is 757 x 451 mm.



Perforated drawer's bottom

Order code	Price (€)
DKP PDZ 4527	7,6,-

For an extra charge the drawers can be furnished with a perforated bottom. It is useful to combine it with a metal divider set. Bars can be tightly screwed to the drawer's bottom.



Individual foam filling of drawer

We are able to produce customized foam fillings according to customer's requirement and given electronic drawings. Minimum order number is 20 pcs.

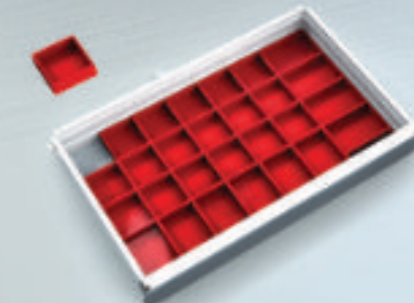
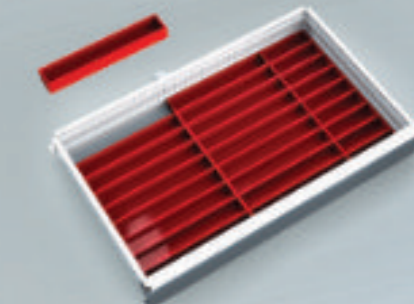

Plastic bins

The plastic bins are intended for dividing the inner drawer's part. On pages 92 and 93 of this catalogue you can find the complete assortment of already configured sets of bins designed directly for particular dimensional lines of drawers. In case that any of those sets do not suit you it is possible to create an individual set. Components for creating the set you will find on page 88.

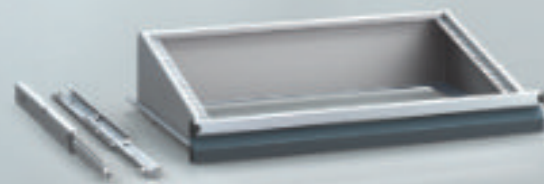

CNC ejecting frame

Order code	Sliding	Carrying capacity(kg)	Price (€)
DSP CNC R A	80 %	90	104,0,-
DSP CNC R B	100 %	65	135,3,-
DSP CNC R C	100 %	180	176,5,-

The ejecting frame is guided in top quality massive slide rails Fullterer. You can choose either a basic version (sliding 80%, carrying capacity 90 kg) or versions with sliding 100% and carrying capacity 65 or 180 kg. The supporting frame is furnished with a comfort aluminium handle with an option to insert a label. The frame is adapted for installation of removable carriers of CNC boxes. The CNC ejecting frame is to be fixed in the same way as drawers, it means to the supporting construction of the DSP 92 PK line.



CNC carriers

Order code	Dimension (mm)	Price (€)
DSP CNC N52	52	57,3,-
DSP CNC N82	82	65,4,-
DSP CNC N102	102	71,2,-

The CNC carriers represent a basic manipulation element which is intended for installation of plastic bins for storing tools. Each carrier is on its both sides furnished with aluminium handles with safety pin which ensures carrier's safe fixation in the ejecting frame. The carriers are available for boxes of sizes 52, 82 and 102 mm. The CNC boxes you will find on page 89 of this catalogue.

System cupboards PROFI

Standard programme



Order code DSP 92 1 S
Info 4 shelves
Price (€) 527,3,-



Order code DSP 92 1 K01
Info 3 shelves + perfo
Price (€) 537,0,-



Order code DSP 92 1 K02 A
Info sliding 80% carrying capacity 90 kg
Price (€) 817,1,-
DSP 92 1 K02 B
Info sliding 100% carrying capacity 65 kg
Price (€) 879,7,-



Order code DSP 92 1 K09 A
Info sliding 80% carrying capacity 90 kg
Price (€) 1115,8,-
DSP 92 1 K09 B
Info sliding 100% carrying capacity 65 kg
Price (€) 1272,3,-
DSP 92 1 K09 C
Info sliding 100% carrying capacity 180 kg
Price (€) 1478,1,-



Order code DSP 92 1 K10
Info 3 shelves + perfo
Price (€) 559,1,-



Order code DSP 92 1 K11 A
Info sliding 80% carrying capacity 90 kg
Price (€) 832,6,-
DSP 92 1 K11 B
Info sliding 100% carrying capacity 65 kg
Price (€) 895,1,-



Order code DSP 92 1 K03 A
Info sliding 80% carrying capacity 90 kg
Price (€) 841,7,-
DSP 92 1 K03 B
Info sliding 100% carrying capacity 65 kg
Price (€) 904,3,-



Order code DSP 92 1 K04 A
Info sliding 80% carrying capacity 90 kg
Price (€) 984,1,-
DSP 92 1 K04 B
Info sliding 100% carrying capacity 65 kg
Price (€) 1109,2,-



Order code DSP 92 1 K05 A
Info sliding 80% carrying capacity 90 kg
Price (€) 1008,7,-
DSP 92 1 K05 B
Info sliding 100% carrying capacity 65 kg
Price (€) 1133,9,-



Order code DSP 92 1 K12 A
Info sliding 80% carrying capacity 90 kg
Price (€) 1006,1,-
DSP 92 1 K12 B
Info sliding 100% carrying capacity 65 kg
Price (€) 1131,3,-



Order code DSP 92 1 K13 A
Info sliding 80% carrying capacity 90 kg
Price (€) 1282,2,-
DSP 92 1 K13 B
Info sliding 100% carrying capacity 65 kg
Price (€) 1501,3,-

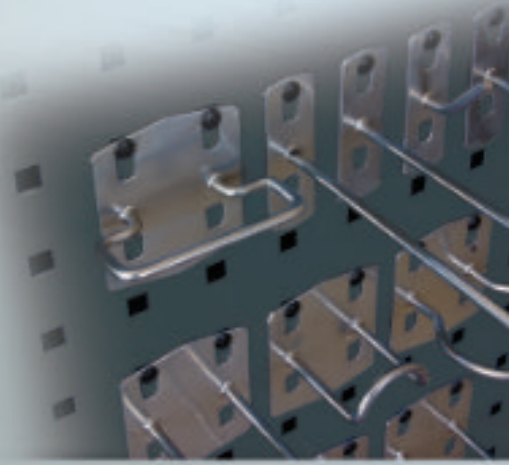

Order code DSP 92 1 K06 A
Info sliding 80% carrying capacity 90 kg
Price (€) 1266,8,-
DSP 92 1 K06 B
Info sliding 100% carrying capacity 65 kg
Price (€) 1485,8,-



Order code DSP 92 1 K07 A
Info sliding 80% carrying capacity 90 kg
Price (€) 1291,4,-
DSP 92 1 K07 B
Info sliding 100% carrying capacity 65 kg
Price (€) 1510,4,-



Order code DSP 92 1 K08 A
Info sliding 80% carrying capacity 90 kg
Price (€) 785,6,-
DSP 92 1 K08 B
Info sliding 100% carrying capacity 65 kg
Price (€) 848,2,-
DSP 92 1 K08 C
Info sliding 100% carrying capacity 180 kg
Price (€) 930,5,-



Order code DSP 92 3 S
Info 2 shelves
Price (€) 361,1,-



Order code DSP 92 3 K01 A
Info sliding 80% carrying capacity 90 kg
Price (€) 548,6,-
DSP 92 3 K01 B
Info sliding 100% carrying capacity 65 kg
Price (€) 579,9,-



Order code DSP 92 3 K02 A
Info sliding 80% carrying capacity 90 kg
Price (€) 715,6,-
DSP 92 3 K02 B
Info sliding 100% carrying capacity 65 kg
Price (€) 809,4,-

Cupboards UNI

Standard programme

The workshop cupboards DSU are price-friendly solution if you want to store materials and tools at production plants. These cupboards are intended for average level of shelf's and drawer's weighting. Among the cupboards DSU there are a lot of standard versions concerning both common versions of workshop cupboards and cupboards for tools incl. versions furnished with a writing desk.



Order code Shelf Body Price (€)
DSU 92 1 S 80 600 430,0,-



Order code Shelf Body Price (€)
DSU 92 1 K01 80 600 432,7,-



Order code Shelf Body Drawer Price (€)
DSU 92 1 K02 80 600 40 593,3,-

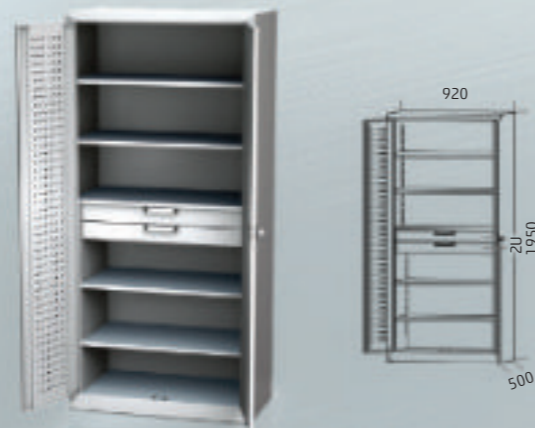

Order code Shelf Body Drawer Price (€)
DSU 92 1 K03 80 600 40 623,2,-



Order code Shelf Body Drawer Price (€)
DSU 92 1 K04 80 600 40 701,5,-



Order code Shelf Body Drawer Price (€)
DSU 92 1 K05 80 600 40 731,4,-



Order code Body Drawer Price (€)
DSU 92 1 K06 600 40 890,6,-



Order code Shelf Body Drawer Price (€)
DSU 92 1 K07 80 600 40 952,5,-



Order code Shelf Body Drawer Price (€)
DSU 92 1 K08 80 600 40 609,6,-



Order code Shelf Body Drawer Price (€)
DSU 92 1 K09 80 600 40 1095,7,-



Order code Shelf Body Price (€)
DSU 92 3 S 80 300 289,8,-



Order code Shelf Body Drawer Price (€)
DSU 92 3 K01 80 300 40 385,8,-



Order code Shelf Body Drawer Price (€)
DSU 92 3 K02 80 300 40 493,9,-







Order code Shelf Body Drawer Price (€)
DSU 92 3 K03 80 300 40 469,4,-



Order code Shelf Body Drawer Price (€)
DSU 92 3 K04 80 300 40 510,6,-



The cupboards for tools with a writing desk are in their upper part furnished with a slanted door. The door has in its bottom part a stop which makes a protection against falling pens and pencils. The space in the writing desk as well as the door placed in the cupboard's bottom part are locked by pair cylindrical locks. Both locks can be opened with a same key.

		
Order code: DSU 49 1 S Shelves: 80 Body: 400 Price (€): 301,0,-	Order code: DSU 49 1 K01 Shelves: 80 Body: 400 Price (€): 302,9,-,-	Order code: DSU 49 1 K02 Shelves: 80 Body: 400 Drawer: 40 Price (€): 417,6,-

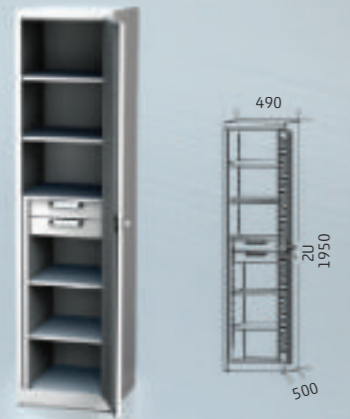
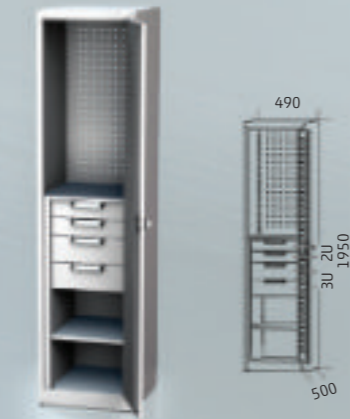
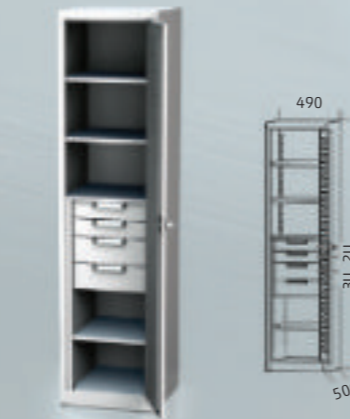
		
Order code: DSU 49 3 P Shelves: 80 Body: 200 Price (€): 204,9,-,-	Order code: DSU 49 3 P01 Shelves: 80 Body: 200 Drawer: 40 Price (€): 246,1,-,-	Order code: DSU 49 3 P02 Shelves: 80 Body: 200 Drawer: 40 Price (€): 277,4,-,-

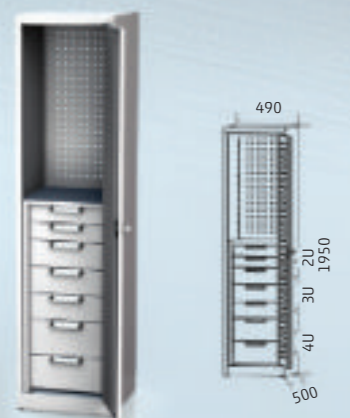
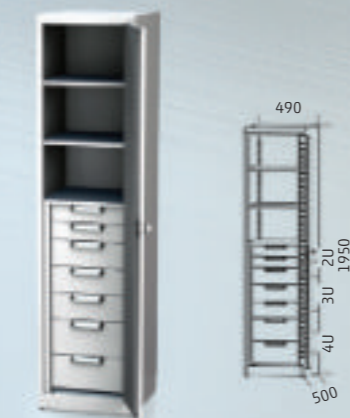

		
Order code: DSU 49 1 K03 Shelves: 80 Body: 400 Drawer: 40 Price (€): 438,6,-,-	Order code: DSU 49 1 K04 Shelves: 80 Body: 400 Drawer: 40 Price (€): 486,4,-,-	Order code: DSU 49 1 K05 Shelves: 80 Body: 400 Drawer: 40 Price (€): 507,4,-,-



		
Order code: DSU 92 3 P Shelves: 80 Body: 200 Price (€): 334,4,-,-	Order code: DSU 92 3 P01 Shelves: 80 Body: 300 Drawer: 40 Price (€): 430,3,-,-	Order code: DSU 92 3 P02 Shelves: 80 Body: 300 Drawer: 40 Price (€): 538,5,-,-

		
Order code: DSU 49 1 K06 Body: 400 Drawer: 40 Price (€): 607,5,-,-	Order code: DSU 49 1 K07 Shelves: 80 Body: 400 Drawer: 40 Price (€): 628,5,-,-	Order code: DSU 49 1 K08 Shelves: 80 Body: 400 Drawer: 40 Price (€): 426,5,-,-

		
Order code: DSU 92 3 P03 Shelves: 80 Body: 300 Drawer: 40 Price (€): 514,0,-,-	Order code: DSU 92 3 P04 Shelves: 80 Body: 300 Drawer: 40 Price (€): 555,2,-,-	Order code: DSU PP80 Price (€): 153,3,-,-

Version with wheelframe
For an extra charge you can order the mobile versions of cupboards. The castor's diameter is 80 mm and it is used 2x fixed and 2x revolving castor with a brake. The total height of the product is heightened of 110 mm after the wheelframe installation.

		
Order code: DSU 49 3 S Shelves: 80 Body: 200 Price (€): 173,7,-,-	Order code: DSU 49 3 K01 Shelves: 80 Body: 200 Drawer: 40 Price (€): 214,9,-,-	Order code: DSU 49 3 K02 Shelves: 80 Body: 200 Drawer: 40 Price (€): 280,3,-,-

	
Order code: NS 45 1 A Shelves: 80 Body: 200 Drawer: 40 Price (€): 196,6,-,-	Order code: NS 45 1 S Shelves: 80 Body: 200 Drawer: 40 Price (€): 95,6,-,-

Universal cupboards US

Standard programme

1 - full doors



The doors are hinged on massive pivots, angle of opening is 110°. On their inner part there is a reinforcing profile. Locking is solved by a turning padlock cap and a three-point locking mechanism.

2 - glass-filled doors



The safety hardened glass is fitted in door's metal frame. The angle of opening is 110°. On their inner part there is a reinforcing profile. Locking is solved by a turning padlock cap and a three-point locking mechanism.

3 - without doors



The cupboard without doors can be used as a stable shelf system.



Shelves 60
Body 300



Shelves 60
Body 300



Shelves 60
Body 200

Order code	Version	Price (€)
US 49 1 S	1 full doors	255,1,-
US 49 1 S S	2 glass-filled doors	306,2,-
US 49 1 R	3 without doors	229,6,-

Order code	Version	Price (€)
US 49 2 S	1 full doors	242,4,-
US 49 2 S S	2 glass-filled doors	290,3,-
US 49 2 R	3 without doors	218,2,-

Order code	Version	Price (€)
US 49 3 S	1 full doors	196,5,-
US 49 3 S S	2 glass-filled doors	234,8,-
US 49 3 R	3 without doors	176,8,-



Shelves 60
Body 150



Shelves 60
Body 100

Order code	Version	Price (€)
US 49 4 S	1 full doors	171,0,-
US 49 4 S S	2 glass-filled doors	205,2,-
US 49 4 R	3 without doors	153,9,-

Order code	Version	Price (€)
US 49 5 S	1 full doors	140,4,-
US 49 5 S S	2 glass-filled doors	170,5,-
US 49 5 R	3 without doors	126,4,-



Shelves 60
Body 300



Shelves 60
Body 300



Shelves 60
Body 200

Order code	Version	Price (€)
US 80 1 S	1 full doors	319,8,-
US 80 1 R	3 without doors	287,8,-

Order code	Version	Price (€)
US 80 2 S	1 full doors	303,8,-
US 80 2 R	3 without doors	273,4,-

Order code	Version	Price (€)
US 80 3 S	1 full doors	246,2,-
US 80 3 R	3 without doors	221,6,-



Shelves 60
Body 150



Shelves 60
Body 100

Order code	Version	Price (€)
US 80 4 S	1 full doors	214,3,-
US 80 4 R	3 without doors	192,8,-

Order code	Version	Price (€)
US 80 5 S	1 full doors	175,8,-
US 80 5 R	3 without doors	158,3,-

The universal cupboards US represent a price-friendly solution for storing materials, tools, documents and office equipment at production plants, warehouses, offices and archives.

The cupboards US are offered in many dimensional versions.



Shelves 60
Body 300



Shelves 60
Body 300



Shelves 60
Body 200

Order code	Version	Price (€)
US 92 1 S	1 full doors	340,2,-
US 92 1 S S	2 glass-filled doors	442,2,-
US 92 1 R	3 without doors	306,2,-

Order code	Version	Price (€)
US 92 2 S	1 full doors	323,2,-
US 92 2 S S	2 glass-filled doors	420,1,-
US 92 2 R	3 without doors	290,8,-

Order code	Version	Price (€)
US 92 3 S	1 full doors	261,9,-
US 92 3 S S	2 glass-filled doors	338,5,-
US 92 3 R	3 without doors	235,8,-



Shelves 60
Body 150



Shelves 60
Body 100

Order code	Version	Price (€)
US 92 4 S	1 full doors	227,9,-
US 92 4 S S	2 glass-filled doors	296,3,-
US 92 4 R	3 without doors	205,1,-

Order code	Version	Price (€)
US 92 5 S	1 full doors	187,1,-
US 92 5 S S	2 glass-filled doors	247,3,-
US 92 5 R	3 without doors	168,4,-



Shelves 60
Body 300



Shelves 60
Body 300

Order code	Version	Price (€)
US 120 1 S	1 full doors	442,2,-
US 120 1 S S	2 glass-filled doors	574,9,-
US 120 1 R	3 without doors	398,0,-

Order code	Version	Price (€)
US 120 2 S	1 full doors	420,1,-
US 120 2 S S	2 glass-filled doors	546,2,-
US 120 2 R	3 without doors	378,1,-



Shelves 60
Body 200



Shelves 60
Body 150

Order code	Version	Price (€)
US 120 3 S	1 full doors	340,5,-
US 120 3 S S	2 glass-filled doors	440,1,-
US 120 3 R	3 without doors	306,5,-

Order code	Version	Price (€)
US 120 4 S	1 full doors	296,3,-
US 120 4 S S	2 glass-filled doors	385,2,-
US 120 4 R	3 without doors	266,7,-



Shelves 60
Body 100

Order code	Version	Price (€)
US 120 5 S	1 full doors	243,3,-
US 120 5 S S	2 glass-filled doors	321,6,-
US 120 5 R	3 without doors	218,9,-

Showcases



Order code Price (€)
US 92 1 G S 632,7,-

The cupboard is furnished with glass-filled doors. The door's fillings are made of safety hardened glass, the shelves are made of safety two-layer glass. Their surface carrying capacity is 5 kg.



Order code Price (€)
US 92 1 L 711,1,-

The cupboard is in its bottom part furnished with a standard shelf and full doors. In its upper part there are glass-filled doors made of safety hardened glass. The shelves are made of safety two-layer glass. Their surface carrying capacity is 5 kg.

Cupboards for chemicals

The cupboards for chemicals are furnished with intercepting container of 15 l volume. The part of container's construction is also a perforated pad. The doors are perforated in their upper and bottom part.



Order code Price (€)
US 92 1 CH 455,8,-

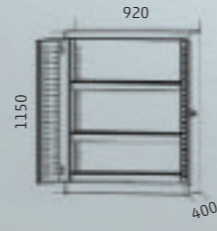

Order code Price (€)
US 92 3 CH 350,4,-

Cupboards for A4 files

The cupboards furnished with ejecting frames of carrying capacity 40 kg are intended for placing of A4 files. The files can be placed in longitudinal or transverse direction.

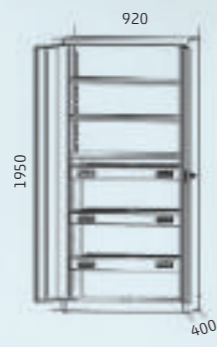

Order code Price (€)
US 92 1 KR 657,2,-

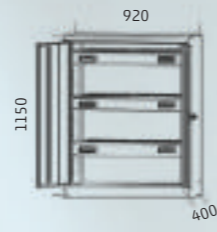

Order code Price (€)
US 92 3 KR 551,5,-

Warehouse cupboards

The cupboards are furnished with special shelves with plastic bins intended for storing small pieces. On the frontal part of the bins there are plates for inserting a label with bin's contents. The bars are removable. The shelf's surface carrying capacity is 60 kg and they are adjustable after 25 mm.

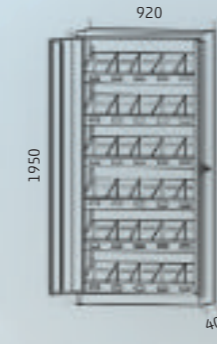

Order code	Version	Price (€)
US 92 1 S K01	1 full doors	585,5,-
US 92 1 S S K01	2 glass-filled doors	687,6,-
US 92 1 R K01	3 without doors	551,5,-



Order code	Version	Price (€)
US 92 1 S K02	1 full doors	705,9,-
US 92 1 S S K02	2 glass-filled doors	808,0,-
US 92 1 R K02	3 without doors	671,9,-



Order code	Version	Price (€)
US 92 1 S K11	1 full doors	938,0,-
US 92 1 S S K11	2 glass-filled doors	1040,0,-
US 92 1 R K11	3 without doors	904,0,-

The cupboards are furnished with warehouse bins of the VariBox system. The bins are available in red, grey, blue or black colour.



Order code	Version	Price (€)
US 92 1 S K12	1 full doors	903,3,-
US 92 1 S S K12	2 glass-filled doors	1005,3,-
US 92 1 R K12	3 without doors	869,2,-

The cupboards are furnished with warehouse bins. The bins are available in red, grey, blue or black colour.



Order code	PPB 2601 VB	PPB 2602 VB	PPB 2603 VB	PPB 2030 Z1	PPB 2031 Z2
------------	-------------	-------------	-------------	-------------	-------------

The table with prices and dimensions of the plastic bins you will find on page 88.



Order code	Dimension (mm)	Price (€)
VS US 49	490	84,0,-
VS US 80	800	121,5,-
VS US 92	920	129,3,-
VS US 120	1200	161,6,-

The cupboards of the VS line can be fitted with a lockable box with wing doors. The doors are lockable by a cylindrical lock EURO-LOCKS. The lock has 2000 combinations and is standardly supplied with 2 keys.

Warehouse cupboards

Standard programme

The warehouse cupboards of the SS and US line are designed for storing small pieces and materials at production or assembly plants and warehouses. The warehouse cupboards are offered in many dimensional versions. Versions without doors or versions intended for mounting on the wall are also available. The cupboards of height 500, 600 or 800 mm can be placed standardly or can be hung on the wall.

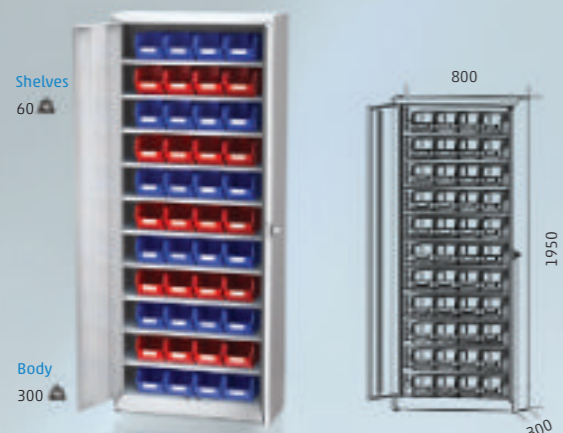

Order code	Number	Plastic bin	Price (€)
SS 80 1 S10 PP	24	SB3M	631,6,-
	20	SB3C	

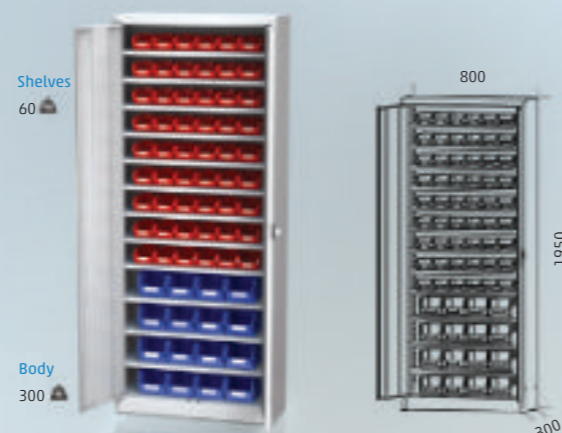

Order code	Number	Plastic bin	Price (€)
SS 80 1 S12 PP	54	SB2C	638,9,-
	16	SB3M	



Order code	Number	Plastic bin	Price (€)
SS 80 4 S4 PP	18	SB2C	336,2,-
	8	SB3M	



Order code	Number	Plastic bin	Price (€)
SS 80 4 S5 PP	36	SB2C	350,1,-

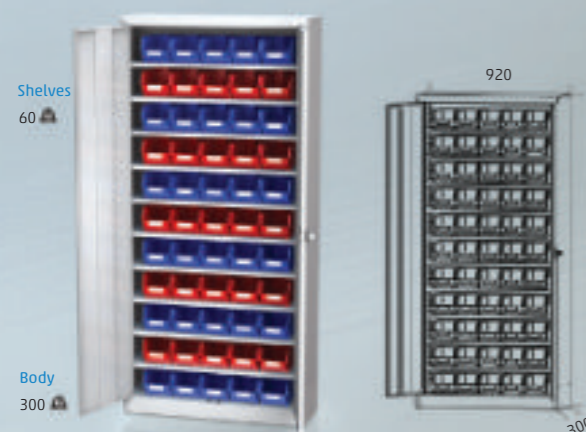

Order code	Number	Plastic bin	Price (€)
SS 92 1 S10 PP	30	SB3M	702,1,-
	25	SB3C	

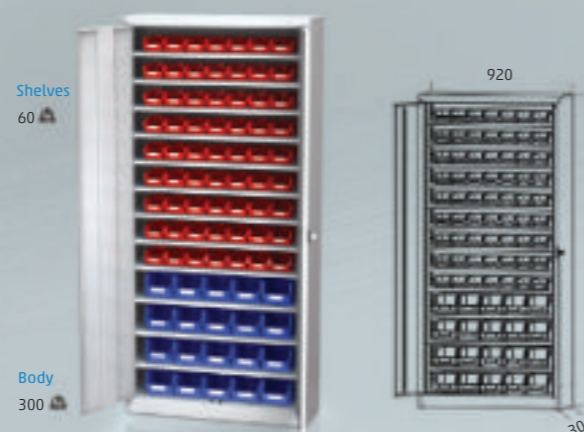

Order code	Number	Plastic bin	Price (€)
SS 92 1 S12 PP	63	SB2C	694,2,-
	20	SB3M	

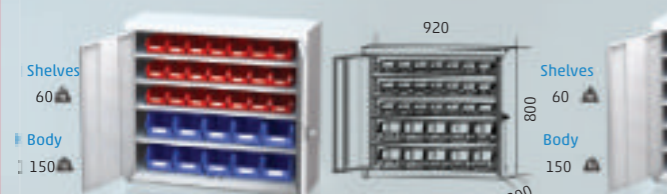

Order code	Number	Plastic bin	Price (€)
SS 92 4 S4 PP	21	SB2C	364,4,-
	10	SB3M	

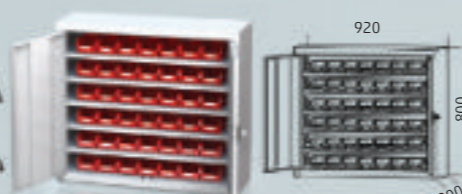

Order code	Number	Plastic bin	Price (€)
SS 92 4 S5 PP	42	SB2C	376,1,-



Order code	Number	Plastic bin	Price (€)
SS 92 5 SP2 PP	7	SB2C	258,9,-
	14	SB2M	



Order code	Number	Plastic bin	Price (€)
US 92 1 S9 PP	24	SB4C	798,5,-
	16	SB4M	

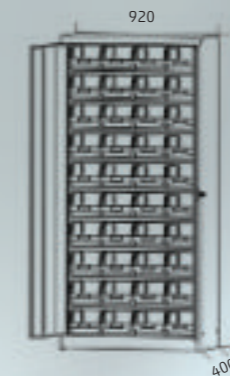

Order code	Number	Plastic bin	Price (€)
US 92 1 S9 PP S	24	SB4C	900,6,-
	16	SB4M	

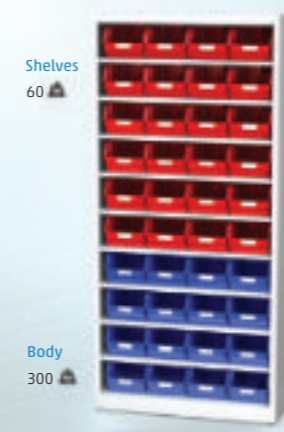

Order code	Number	Plastic bin	Price (€)
US 92 1 R9 PP	24	SB4C	713,5,-
	16	SB4M	



Order code	Price (€)
SS 600 1200 200 EP	286,7,-

Plastic bins

The plastic bins are made of knock and chemicals resistant polyethylene. Temperature resistance is -10 - +50°C.

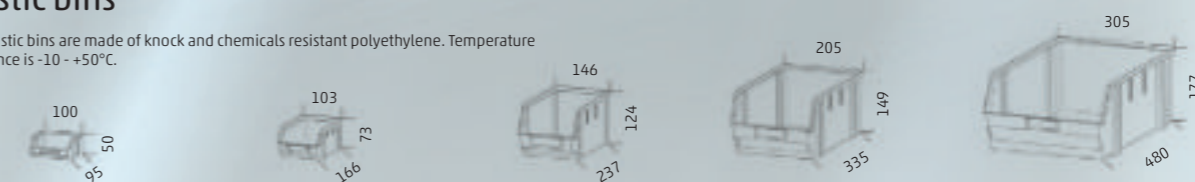

Order code	Price (€)	Order code	Price (€)	Order code	Price (€)	Order code	Price (€)	Order code	Price (€)
SB1Z	0,8,-	SB2Z	1,6,-	SB3Z	4,4,-	SB4Z	8,7,-	SB5Z	15,7,-
SB1M	0,8,-	SB2M	1,6,-	SB3M	4,4,-	SB4M	8,7,-	SB5M	15,7,-
SB1C	0,8,-	SB2C	1,6,-	SB3C	4,4,-	SB4C	8,7,-	SB5C	15,7,-



EUROPERFO® and ALFABOX® system stands

The mobile system stands are designed for everyday hard using at industry assembly plants. The stands are made of a resistant construction and are furnished with a manipulation handle and a wheelframe fitted with 2x fixed and 2x revolving castors with a brake. The castor's diameter is 100 mm.

The basic supporting construction can be furnished with EUROPERFO® panels with perforation slots intended for mounting holders for tools or with ALFABOX® panels intended for hanging of plastic bins or shelves.







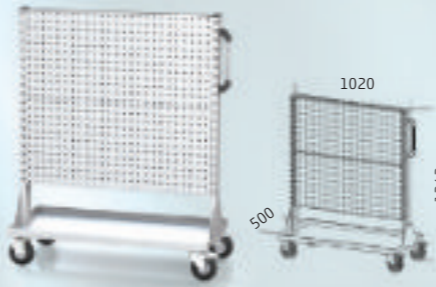
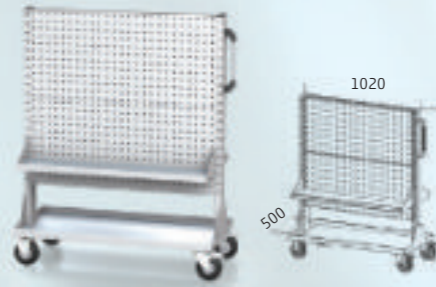

In the standard assortment you will find the basic versions of mobile stands. In case of inquiry for nonstandard configuration please contact our sales department.

The stationary system stands are designed to furnish industry assembly plants, warehouses and shops with tools and hardware. The stands are produced in basic or additional versions. You can create coherent walls fitted with EUROPERFO® panels with perforation slots intended for mounting holders for tools or with ALFABOX® panels intended for hanging of plastic bins or shelves. In the standard assortment you will find the standard versions of stationary stands. On demand we can also supply versions with an illuminated billboard in the upper part of the stand or with a cupboard with lockable drawers in the stand's bottom part.

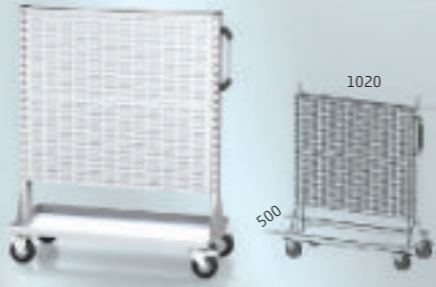
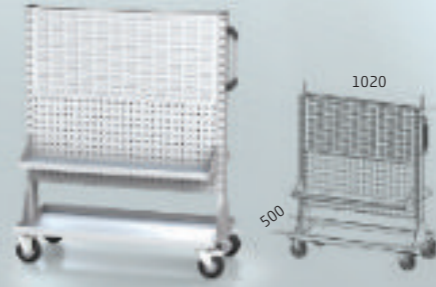
The stationary stands must be anchored to the wall.

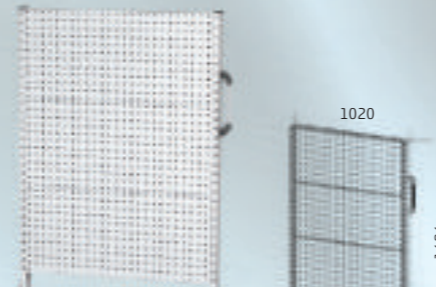
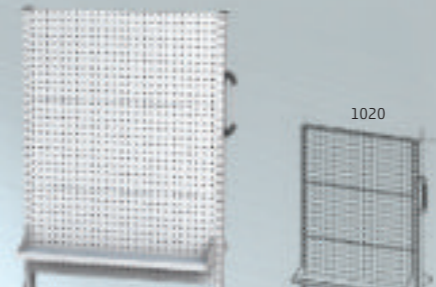
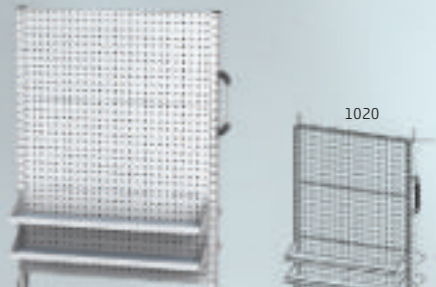
Mobile system stands

Standard programme

	1020 500 1242		1020 500 1242		1020 500 1242
Order code DES 102P 20U K01	Price (€) 436,8,-	Order code DES 102P 20U K02	Price (€) 764,4,-	Order code DES 102P 20U K03	Price (€) 746,4,-
	1020 500 1242		1020 500 1242		1020 500 1242
Order code DES 102P 20U K04	Price (€) 846,0,-	Order code DES 102P 20U K05	Price (€)	Order code DES 102P 20U K06	Price (€)
	1020 500 1686		1020 500 1686		1020 500 1686
Order code DES 102P 30U K01	Price (€)	Order code DES 102P 30U K02	Price (€)	Order code DES 102P 30U K03	Price (€)
	1020 500 1686		1020 500 1686		1020 500 1686
Order code DES 102P 30U K04	Price (€)	Order code DES 102P 30U K05	Price (€)	Order code DES 102P 30U K06	Price (€)

The mobile stands can be ordered in colour shades of the Klasik colour chart, so the frames, panels and shelves can be of different colours.





Drawer cabinets PROFI

dimensional line	2727E	3627E	4527E	5427E
	3636E	4536E	5436E	

Drawer cabinets UNI

Workshop trolleys

Workbenches

ALCERA	ALPEDE
ALSOR	ALNAK

Workshop cabinets

system	universal
warehouse	

Perfo systems

mobile
stationary

Holders for tools

Plastic bins

Computer cabinets

Fire extinguishers

Surface treatment

Stationary system stands

Standard programme



Order code	Price (€)
DES 102S 10U K01 B 1	143,9,-
DES 102S 10U K01 P 2	118,3,-



Order code	Price (€)
DES 102S 10U K02 B 1	193,6,-
DES 102S 10U K02 P 2	168,1,-

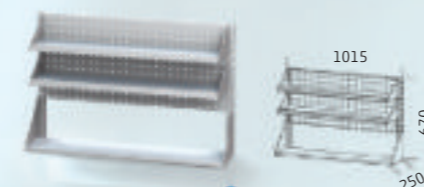

Order code	Price (€)
DES 102S 10U K03 B 1	243,4,-
DES 102S 10U K03 P 2	217,9,-

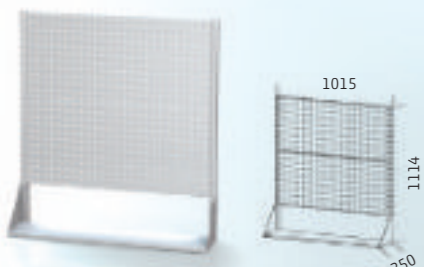

Order code	Price (€)
DES 102S 20U K01 B 1	212,5,-
DES 102S 20U K01 P 2	178,2,-

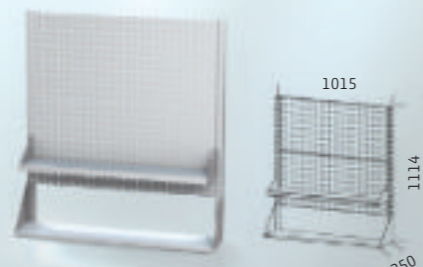

Order code	Price (€)
DES 102S 20U K02 B 1	262,4,-
DES 102S 20U K02 P 2	228,0,-

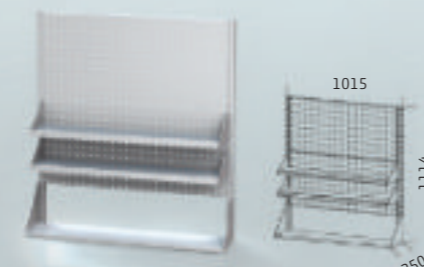

Order code	Price (€)
DES 102S 20U K03 B 1	312,2,-
DES 102S 20U K03 P 2	277,8,-

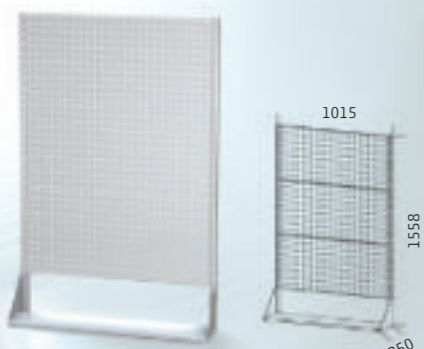

Order code	Price (€)
DES 102S 30U K01 B 1	274,6,-
DES 102S 30U K01 P 2	234,7,-

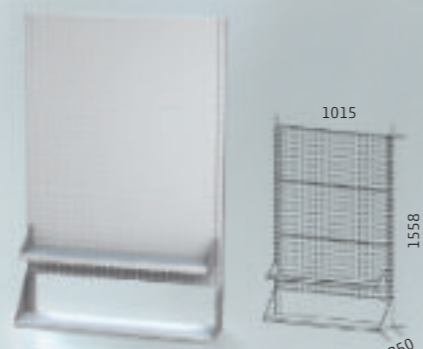

Order code	Price (€)
DES 102S 30U K02 B 1	324,4,-
DES 102S 30U K02 P 2	284,5,-

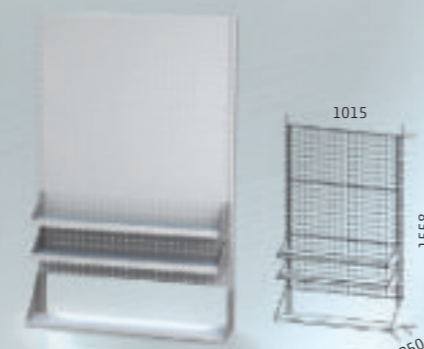

Order code	Price (€)
DES 102S 30U K03 B 1	374,2,-
DES 102S 30U K03 P 2	334,3,-

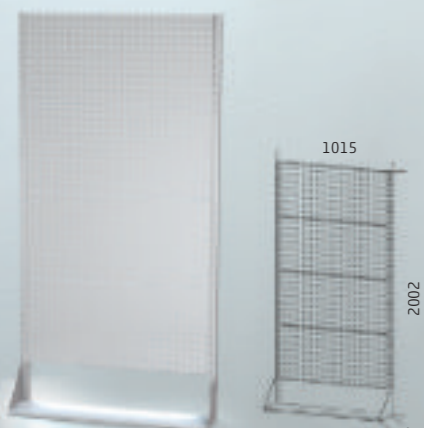

Order code	Price (€)
DES 102S 40U K01 B 1	333,2,-
DES 102S 40U K01 P 2	289,6,-

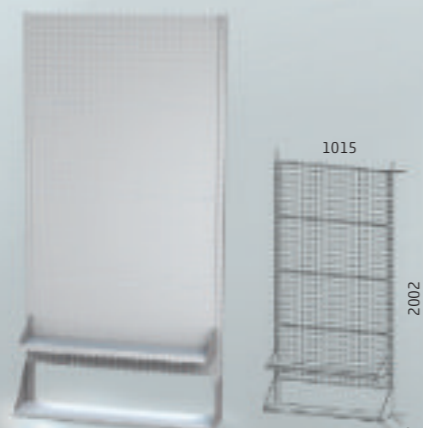

Order code	Price (€)
DES 102S 40U K02 B 1	383,0,-
DES 102S 40U K02 P 2	339,4,-

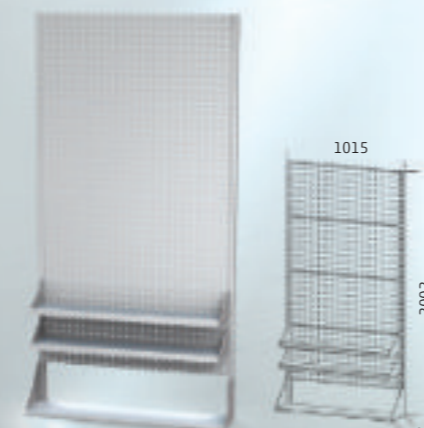

Order code	Price (€)
DES 102S 40U K03 B 1	432,8,-
DES 102S 40U K03 P 2	389,1,-

System workshop stand

The stands are produced in four heights. The base of the construction is 250 mm deep and the vertical profiles are furnished with slots for anchoring to the wall. The profile's perforation allows mounting shelves, EUROPERFO or ALFABOX panels or other accessories from individual programme which can be found in workbench's assortment.

The stationary stands can be ordered in colour shades of the Klasik colour chart, so the frames, panels and shelves can be of different colours.



Order code	Price (€)
DES 102S 10U K04 B 1	164,2,-
DES 102S 10U K04 P 2	138,7,-



Order code	Price (€)
DES 102S 20U K04 B 1	253,4,-
DES 102S 20U K04 P 2	219,0,-

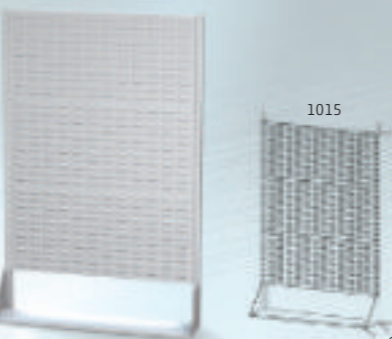

Order code	Price (€)
DES 102S 30U K04 B 1	335,8,-
DES 102S 30U K04 P 2	296,0,-

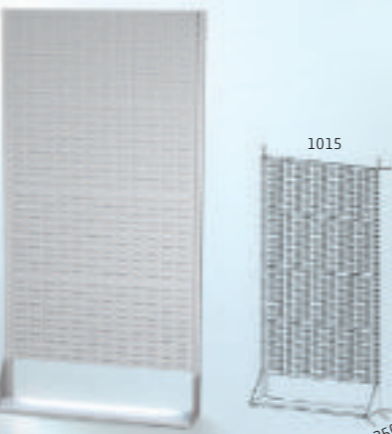

Order code	Price (€)
DES 102S 40U K04 B 1	414,9,-
DES 102S 40U K04 P 2	371,2,-



Order code	Price (€)
DES 102S 20U K05 B 1	282,7,-
DES 102S 20U K05 P 2	248,4,-

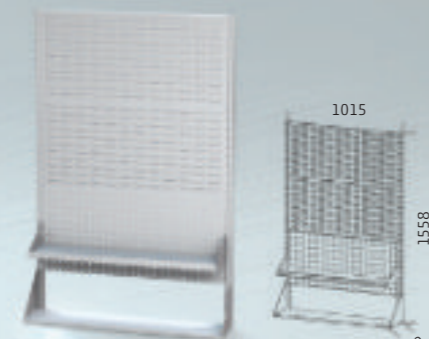

Order code	Price (€)
DES 102S 30U K05 B 1	365,2,-
DES 102S 30U K05 P 2	325,3,-

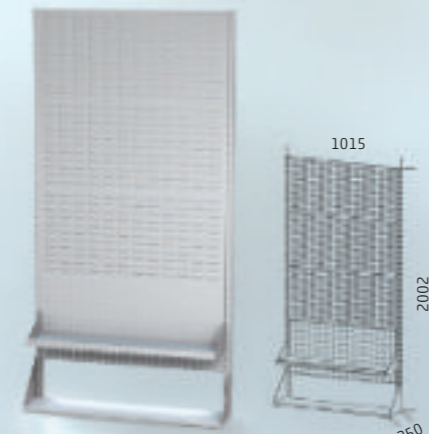

Order code	Price (€)
DES 102S 40U K05 B 1	444,3,-
DES 102S 40U K05 P 2	400,6,-



Order code	Price (€)
DES 102S 20U K06 B 1	332,6,-
DES 102S 20U K06 P 2	298,2,-

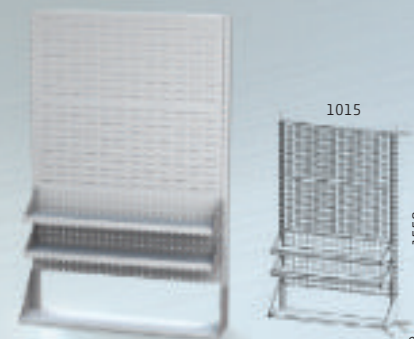

Order code	Price (€)
DES 102S 30U K06 B 1	415,0,-
DES 102S 30U K06 P 2	375,1,-

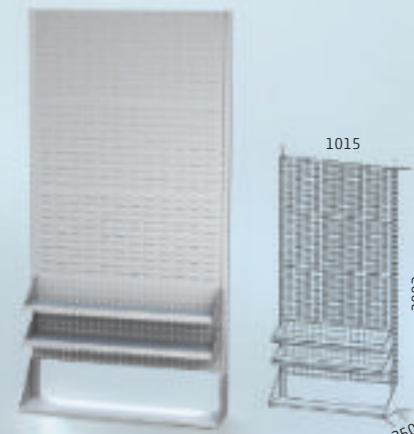

Order code	Price (€)
DES 102S 40U K06 B 1	494,0,-
DES 102S 40U K06 P 2	450,4,-



Drawer cabinets PROFI

dimensional line	2727E	3627E	4527E	5427E
	3636E	4536E	5436E	

Drawer cabinets UNI

Workshop trolleys

Workbenches

ALCERA	ALPEDE
ALSOR	ALNAK

Workshop cabinets

system	universal
warehouse	

Perfo systems

mobile
stationary

Holders for tools

Plastic bins

Computer cabinets

Fire extinguishers

Surface treatment

Swing boxes



Order code	Outer dimension (mm)	Inner dimension (mm)	No. of boxes	Price (€)
PPB 2248 SW 100 x 100/4/2	102 x 102 x 94	44 x 39 x 67	4	9,5,-
PPB 2249 SW 100 x 100/4	102 x 102 x 94	44 x 39 x 67	4	9,3,-
PPB 2250 SW 100 x 100/2	102 x 102 x 94	90 x 39 x 67	2	8,3,-
PPB 2251 SW 100 x 100/1	102 x 102 x 94	90 x 86 x 67	1	7,7,-
PPB 2252 SW 100 x 150/1	152 x 102 x 94	139 x 86 x 67	1	8,9,-
PPB 2255 SW 150 x 150/1	152 x 152 x 94	139 x 138 x 67	1	11,4,-
PPB 2059 D	72 x 102 x 15	* adapter for mounting on a workbench		3,7,-

* note

The swing boxes are furnished with little removable tilting or ejecting boxes. They are intended for storing small pieces and materials. On their circumference they are furnished with a dovetail joint so they can be connected and make bigger wholes. The bins are made of ABS and they are standardly in red colour. Alternatively the bins in blue colour can be ordered.

The boxes are in their rear part furnished with slots so they can be mounted on the wall or using an adapter they can be fitted to a work desk.



Warehouse bins

Order code	Name	Outer dimension (mm)	Price (€)
PPB 2030 Z1	drawer	83 x 91 x 300	5,0,-
PPB 2031 Z2	drawer	83 x 182 x 300	8,1,-
PPB 2081 ZP	pallet bin	100 x 150 x 400	6,9,-
PPB 2082	pallet bin connector	44 x 22 x 11	0,2,-
PPB 2083 PR	pallet bin bar	89 x 144 x 7	0,8,-

The warehouse bins are used for storing small pieces and materials. In our offer you can find drawers for cupboards of the US line and pallet bins with a tilting frontal part.



VariBoxes



Order code	Outer dimension (mm)	Inner dimension (mm)	No. of drawers	Price (€)
PPB 2661 VB	533 x 1002 x 355	78 x 99 x 310	48	606,4,-
PPB 2662 VB	533 x 1002 x 355	78 x 218 x 310	24	566,2,-
PPB 2663 VB	533 x 1002 x 355	164 x 215 x 308	12	478,5,-
PPB 2601 VB	85 x 118 x 346	78 x 99 x 310		7,2,-
PPB 2602 VB	85 x 236 x 346	78 x 218 x 310		9,7,-
PPB 2603 VB	174 x 236 x 346	164 x 215 x 308		15,1,-
PPB 2611 PR	78 x 107 x 7	* bar for PPB 2601 VB		1,4,-
PPB 2612 PR	78 x 225 x 7	* bar for PPB 2602 VB		1,8,-
PPB 2613 PR	164 x 224 x 7	* bar for PPB 2603 VB		2,9,-

* note

The VariBox system is a variable unit-principle system suitable especially for furnishing of warehouses and assembly plants. The configured drawer blocks are suitable for storing small materials and small spare parts. The drawers can be used separately or in combination with the US cupboards. The body's construction is available in grey or black colour. The drawers can be ordered in light grey, blue, red or black colour.

We can make a special offer of VariBox set on the customer's demand.



Special plastic boxes

Boxes for drills, screw taps and imbus keys

Order code	Outer dimension (mm)	Diameter (mm)	No. of slots	Price (€)
PPB 2023 BOX D1-D4,9	72 x 202 x 52	1-4,9 after 0,1	40	7,1,-
PPB 2024 BOX D5-D7,9	72 x 202 x 52	5-7,9 after 0,1	40	7,1,-
PPB 2025 BOX D8-D9,9	72 x 202 x 52	8-9,9 after 0,1	40	7,1,-
PPB 2026 BOX D10-D11,9	72 x 202 x 52	10-11,9 after 0,1	40	7,1,-
PPB 2027 BOX D12-D13,9	72 x 202 x 52	12-13,9 after 0,1	40	7,1,-
PPB 2028 BOX D1-D13,5	72 x 202 x 52	1-13,5 after 0,5 + 3,2 + 4,3 + 6,8	30	7,1,-
PPB 2071 BOX M3-M12	72 x 202 x 52	* for screw taps M3-M12	28	7,1,-
PPB 2043 IK 2-10	72 x 52 x 52	* for imbus keys 2-10	8	4,0,-
PPB S1	308 x 202 x 72	* for drills ? 1-13,9 after 0,1	200	43,0,-

* note

The plastic boxes are used for storing tools. The boxes can be put directly in drawers, they can be fitted into the CNC carriers or they can be mounted by adapters on the work desks or on the wall. On their circumference they are furnished with a dovetail joint so they can be connected and make bigger wholes. The boxes are made of ABS and they are standardly in red colour. Alternatively the boxes in blue colour can be ordered.

If you are interested we are able to offer also boxes for spring collets and electrodes for sinking machines.

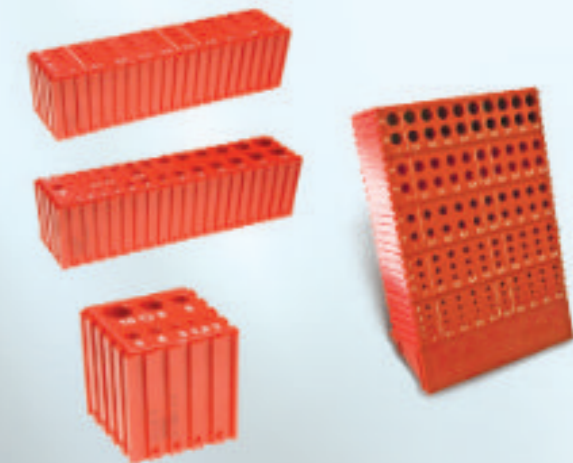

Additional items

Order code	Name	Outer dimension (mm)	Price (€)
PPB 2029 MD 12 x 12	filling	72 x 12 x 12	0,7,-
PPB 2019 MD 22 x 22	filling	72 x 22 x 22	1,4,-
PPB 2020 K	wedge for mounting on a workbench	72 x 100 x 100	3,8,-
PPB 2078 AP	EUROPERFO adapter	97 x 100 x 19,5	3,7,-
PPB 2021 ST	label	36 x 75 x 4,5	0,5,-



Special suitcases and other cases

We dispose of our own workshop where we produce suitcases, cases and transport boxes. All the assortment is handmade of high quality components supplied by prestigious suppliers. We offer a small series production in dimensions on customer's demand. We can also produce a filling according to the shape and dimensions of the stored items.

The suitcases, boxes and other cases are designed especially for storing medical equipment, tools, weapons, audiovisual and enlightening technologies, measuring devices, IT etc.

Below there are shown three basic dimensional versions of suitcases made of aluminium, plywood and artificial leather without internal equipment.

Order code	Length (mm)	Depth (mm)	Height (mm)	Price (€)
KF 35 50 12 A	500	350	120	293,5,-
KF 40 60 15 A	600	400	150	313,5,-
KF 50 70 20 A	700	500	200	333,5,-

If you are interested in making a special offer please contact us. We are able to make a special offer according to the given specifications.

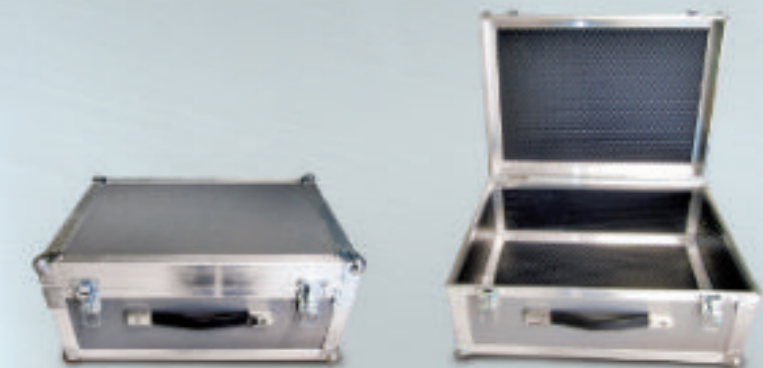



dimensional line	2727E	3627E	4527E	5427E
	3636E	4536E	5436E	

ALCERA	ALPEDE
ALSOR	ALNAK

system	universal
warehouse	

mobile	stationary
--------	------------

Sets of plastic boxes for system drawers

For each dimensional line of system drawers of the DKP and DSP line cabinets we have designed four versions of sets of plastic boxes. The sets are intended for storing tools, gauges, materials and small parts in well-arranged way. If none of the shown version fit your requirements, we are able to design an individually configured set. The sets of boxes can be further furnished for an extra charge with foam filling, bars or filling for horizontal tool storing.



Drawers 2727

Order code PPB S 2727 1	Order code PPB S 2727 2	Order code PPB S 2727 3	Order code PPB S 2727 4
Dimension (mm) 35 x 450 x 450	Dimension (mm) 35 x 450 x 450	Dimension (mm) 35 x 450 x 450	Dimension (mm) 35 x 450 x 450
Price (€) 48,4,-	Price (€) 58,5,-	Price (€) 48,1,-	Price (€) 52,5,-

Drawers 3627

Order code PPB S 3627 1	Order code PPB S 3627 2	Order code PPB S 3627 3	Order code PPB S 3627 4
Dimension (mm) 35 x 600 x 450	Dimension (mm) 35 x 600 x 450	Dimension (mm) 35 x 600 x 450	Dimension (mm) 35 x 600 x 450
Price (€) 56,3,-	Price (€) 80,4,-	Price (€) 62,8,-	Price (€) 69,4,-

Drawers 3636

Order code PPB S 3636 1	Order code PPB S 3636 2	Order code PPB S 3636 3	Order code PPB S 3636 4
Dimension (mm) 35 x 600 x 600	Dimension (mm) 35 x 600 x 600	Dimension (mm) 35 x 600 x 600	Dimension (mm) 35 x 600 x 600
Price (€) 75,1,-	Price (€) 112,6,-	Price (€) 85,7,-	Price (€) 92,4,-

Drawers 4527

Order code PPB S 4527 1	Order code PPB S 4527 2	Order code PPB S 4527 3	Order code PPB S 4527 4
Dimension (mm) 35 x 750 x 450	Dimension (mm) 35 x 750 x 450	Dimension (mm) 35 x 750 x 450	Dimension (mm) 35 x 750 x 450
Price (€) 76,5,-	Price (€) 98,7,-	Price (€) 81,2,-	Price (€) 87,7,-

Drawers 4536

Order code PPB S 4536 1	Order code PPB S 4536 2	Order code PPB S 4536 3	Order code PPB S 4536 4
Dimension (mm) 35 x 750 x 600	Dimension (mm) 35 x 750 x 600	Dimension (mm) 35 x 750 x 600	Dimension (mm) 35 x 750 x 600
Price (€) 102,0,-	Price (€) 136,7,-	Price (€) 109,8,-	Price (€) 114,0,-

Drawers 5427

Order code PPB S 5427 1	Order code PPB S 5427 2	Order code PPB S 5427 3	Order code PPB S 5427 4
Dimension (mm) 35 x 900 x 450	Dimension (mm) 35 x 900 x 450	Dimension (mm) 35 x 900 x 450	Dimension (mm) 35 x 900 x 450
Price (€) 84,5,-	Price (€) 120,6,-	Price (€) 94,3,-	Price (€) 106,0,-

Drawers 5436

Order code PPB S 5436 1	Order code PPB S 5436 2	Order code PPB S 5436 3	Order code PPB S 5436 4
Dimension (mm) 35 x 900 x 600	Dimension (mm) 35 x 900 x 600	Dimension (mm) 35 x 900 x 600	Dimension (mm) 35 x 900 x 600
Price (€) 112,6,-	Price (€) 169,0,-	Price (€) 128,6,-	Price (€) 137,6,-

	Drawer cabinets PROFI			
dimensional line	2727E	3627E	4527E	5427E
	3636E	4536E	5436E	

Drawer cabinets UNI

Workshop trolleys

Workbenches	
ALCERA	ALPEDE
ALSOR	ALNAK

Workshop cabinets	
system	universal
warehouse	

Perfo systems	
mobile	stationary

Holders for tools

Plastic bins

Computer cabinets

Fire extinguishers

Surface treatment

Computer cabinets

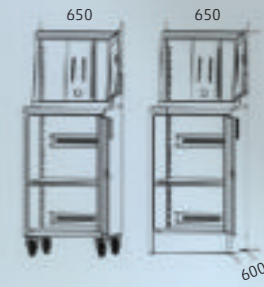

Order code	Price (€)	Order code	Price (€)
CSP 65 1 C	778,6,-	CSS 65 1 C	668,5,-

The basic computer cabinet is intended for placing a computer with an LCD monitor and external equipment at plants. The upper part of the cabinet is furnished with a glass-filled door made of 4 mm thick safety glass. The upper part is intended for placing an LCD monitor without up to 20". A monitor of 115 mm maximal depth can be placed directly on the cabinet's holder with slots in VESA 75 or 100 mm standard. The dimensions of the place for a monitor are 470 x 570 x 115 mm. A keyboard and a mouse is placed on the outer surface in the cabinet's bottom part in front of door for a monitor. In the bottom part there is place for a computer, a printer or other devices. The part of the standard version is a shelf adjustable after 25 mm. In the back wall of the cabinet there are covers with ventilation slots and cable outlets. The versions on a socle with a height adjustment or on wheelframe are available. The cabinet is well prepared for mounting accessories.



The ejecting shelf can be mounted into the cabinets of the A and B versions. It is adjustable after 25 mm. Its carrying capacity is 40 kg, sliding is 350 mm, usable shelf's surface is 530 x 420 mm.

Order code	Price (€)
POV CS 65 1	40,0,-



Into the bottom part of the cabinets of the A and B versions can be mounted mouldings for 19" rack components. The usable height 17U is available. The function of the computer cabinet can be easily increased and you can make of it e.g. a server cabinet.

Order code	Price (€)
RCK CS 65 A	29,0,-

The distribution switchgear can be mounted into the cabinet's back wall. It can be also mounted into the upper or bottom part of the bottom lockable compartment. The mounting from the cabinet's back side does not make the usable inner space smaller.

Order code	Price (€)
EGK CS 65 4Z	185,2,-

The distribution switchgear with forced ventilation can be mounted into the cabinet's back wall. It can be also mounted into the upper or bottom part of the bottom lockable compartment. The mounting from the cabinet's back side does not make the usable inner space smaller.

Order code	Price (€)
EGK CS 65 4ZV	268,5,-



The computer cabinet is intended for placing a computer and external equipment at plants. The upper part of the cabinet is furnished with a glass-filled door made of 4 mm thick safety glass. The upper part is intended for placing an LCD monitor on stand or a CRT monitor up to 20". The dimensions of the place for a monitor are 470 x 570 x 550 mm. An ejecting shelf for a keyboard and a mouse is placed under a lockable tilting door. In the bottom part there is place for a computer, a printer or other devices. The part of the standard version is a shelf adjustable after 25 mm. In the back wall of the cabinet there are covers with ventilation slots and cable outlets. The versions on a socle with a height adjustment or on wheelframe are available. The cabinet is well prepared for mounting accessories.

For an extra charge you can order an ejecting shelf for a printer, a moulding for 19" rack accessory mounting or a distribution switchgear with sockets or a combined distribution switchgear with sockets and a ventilator. The distribution switchgears are to be mounted into the back wall of the cabinet.

Order code	Price (€)	Order code	Price (€)
CSP 65 1 A	884,8,-	CSS 65 1 A	824,6,-

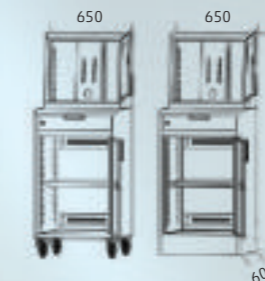

The computer cabinet is intended for placing a computer with an LCD monitor and external equipment at plants. The upper part of the cabinet is furnished with a glass-filled door made of 4 mm thick safety glass. The upper part is intended for placing an LCD monitor without up to 20". A monitor of 115 mm maximum depth can be placed directly on the cabinet's holder with slots in VESA 75 or 100 mm standard. The dimensions of the place for a monitor are 470 x 570 x 115 mm. An ejecting shelf for a keyboard and a mouse is placed under a lockable tilting door. In the bottom part there is place for a computer, a printer or other devices. The part of the standard version is a shelf adjustable after 25 mm. In the back wall of the cabinet there are covers with ventilation slots and cable outlets. The versions on a socle with a height adjustment or on wheelframe are available. The cabinet is well prepared for mounting accessories.

Order code	Price (€)	Order code	Price (€)
CSP 65 1 B	945,0,-	CSS 65 1 B	834,8,-

Cabinets for fire extinguishers and first aid kits

The cabinets for extinguishers are produced in two versions. The cabinets intended for using in interiors are signed HPI, the cabinets for using in exteriors have a roof of zinc-galvanized sheet and are signed HPV.













The cabinets for fire extinguishers are constructed as resistant weldments with full rear part and with wing-doors. In the door plate there is a key holder placed behind the breakable glass. The cabinet is furnished with slots for placing the sealing. In our offer you can find the cabinets in size for FE 6 Kg in two heights, FE 9 Kg and FE CO2. It is possible to choose among versions for 1 up to 4 extinguishers. The cabinets are furnished with a self-adhesive label with the symbol of extinguisher. The surface treatment is solved by powder coating, standardly in RAL 3000 - flame red, alternatively they can be supplied in white colour. The part of the supply are two keys and the material for anchoring into the wall. For an extra charge it is possible to produce the cabinets in stainless version or in version designed for inbuilding into the wall.

Recommended using:













- shops and supermarkets
- parkings and garages
- offices and administrative blocks
- blocks of flats
- production plants
- hotels





Exterior cabinets for fire extinguishers

 Order code: HPV 6 1 A Price (€): 87,8,-	 Order code: HPV 6 2 A Price (€): 126,2,-	 Order code: HPV 6 4 A Price (€): 233,2,-
 Order code: HPV 6 1 B Price (€): 94,4,-	 Order code: HPV 6 2 B Price (€): 135,0,-	 Order code: HPV 6 4 B Price (€): 249,1,-
 Order code: HPV 9 1 A Price (€): 109,8,-	 Order code: HPV 9 2 A Price (€): 156,3,-	 Order code: HPV 9 4 A Price (€): 288,1,-
 Order code: HPV CO 1 A Price (€): 101,0,-	 Order code: HPV CO 2 A Price (€): 153,6,-	 Order code: HPV CO 4 A Price (€): 279,9,-

Interior cabinets for fire extinguishers

 Order code: HPI 6 1 A Price (€): 65,8,-	 Order code: HPI 6 2 A Price (€): 82,3,-	 Order code: HPI 6 4 A Price (€): 156,3,-
 Order code: HPI 6 1 B Price (€): 72,4,-	 Order code: HPI 6 2 B Price (€): 91,1,-	 Order code: HPI 6 4 B Price (€): 172,3,-
 Order code: HPI 9 1 A Price (€): 84,5,-	 Order code: HPI 9 2 A Price (€): 105,9,-	 Order code: HPI 9 4 A Price (€): 199,7,-
 Order code: HPI CO 1 A Price (€): 79,0,-	 Order code: HPI CO 2 A Price (€): 109,8,-	 Order code: HPI CO 4 A Price (€): 203,0,-

First aid kits

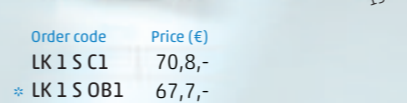
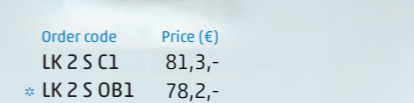
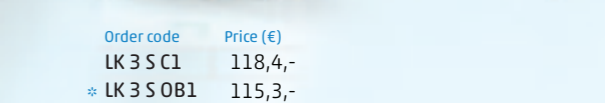
 Order code: LK 1 S C1 Price (€): 70,8,-	 Order code: LK 2 S C1 Price (€): 81,3,-	 Order code: LK 3 S C1 Price (€): 118,4,-
 * LK 1 S OB1 Price (€): 67,7,-	 * LK 2 S OB1 Price (€): 78,2,-	 * LK 3 S OB1 Price (€): 115,3,-

* version with simple locking and a turning padlock

The metal first aid kits are constructed as resistant weldments. We offer them in three dimension lines and two versions with simple locking with turning padlock or with locking by cylindrical lock and a key holder placed behind the breakable glass. The basic versions of the first aid kits have shelves in the body and in the doors they are furnished with heightened edges protecting the stored medical material against falling. The first aid kits are furnished with a self-adhesive label with an appropriate symbol.



Drawer cabinets PROFI

dimensional line	2727E	3627E	4527E	5427E
	3636E	4536E	5436E	

Drawer cabinets UNI

Workshop trolleys

Workbenches

ALCERA	ALPEDE
ALSOR	ALNAK

Workshop cabinets

system	universal
warehouse	

Perfo systems

mobile	stationary
--------	------------

Holders for tools

Plastic bins

Computer cabinets

Fire extinguishers

Surface treatment

Surface treatment

The standard surface treatment is intended for normal interior environment without aggressive impacts. In painting line IDEAL-LINE on the surface of metal parts there is applied a Fe-phosphate layer. It ensures a better adhesion of the powder coat to the metal base. Then in the automatic painting cabine GEMA MagicCylinder II the powder coat in required shade is applied in electrostatic field. The coat is then hardened in a kiln at temperature 180 °C. The final coat is hygienic, flexible and scratch resistant.

Powder coat
Fe-phosphate
Steel plate

RAL 7035 Body colour
RAL 7035 Door, drawer colour
 RAL 7035 Body colour
RAL 5012 Door, drawer colour
 RAL 7035 Body colour
RAL 7016 Door, drawer colour
 RAL 7035 Body colour
RAL 2004 Door, drawer colour
 RAL 7035 Body colour
RAL 7035 Body colour
RAL 3000 Door, drawer colour
 RAL 7035 Body colour
RAL 5010 Door, drawer colour
 RAL 7035 Body colour
RAL 3000 Door, drawer colour
 RAL 7035 Body colour
RAL 6024 Door, drawer colour
 RAL 7035 Body colour
RAL 1023 Door, drawer colour
 RAL 7035 Body colour
RAL 5009 Door, drawer colour

ESD surface treatment Body colour

ESD surface treatment Door, drawer colour

For an extra charge we can paint our products in special ESD conductive colour. It is available in light grey shade with diffused dark particles. The part of treatment is also a conductive connection of movable parts of the product.

Colour combinations of body painted in RAL 7035 - pale grey with doors painted in any shade of the KLASIK chart are included in the basic price, so there is no extra charge.

Coating in other colours of the RAL chart is possible for an individually calculated extra charge.

Silhouettes

Security instructions

Do not overweight the maximum allowed carrying capacity of the shelves, drawers and bodies. The maximum carrying capacity of the shelves and drawers is given for the surface static weighting.

When you put objects into the cupboards, bear in mind the right weight distribution. The heaviest objects store in the lower shelves or drawers and the lightest in the upper ones.

When it is technically possible, anchor the bodies to the wall or to the floor. In case of installation by cupboards ´ backs against each other, screw their bodies together.

When the drawer cabinets cannot be anchored we recommend choosing the type with a system blocking the opening of several drawers together. This system is a protection against cabinet ´ s overturning due to the change of the gravity centre.

When you want to buy a mobile drawer cabinet we recommend furnishing the drawers with a safety pin protecting them against their spontaneous opening. The safety pin protects against opening of the unlocked drawers during going on a slip plane.

When you buy a mobile cabinet which is not furnished with a safety pin against spontaneous opening of unlocked drawers you have to lock the drawers properly before moving the cabinet.

Any object stored in the drawer must not overlap the edge of the drawer ´ s side walls.

Do not step on shelves or in the drawers.

Use only the original accessories approved by the producer.

98

99



ALFA 3, s.r.o.
Husova 247
538 54 Luže

Tel.: +420 469 671 295

e-mail: obchod@alfa3.cz

An updated list of authorized sellers you will find on

www.alfa3.cz

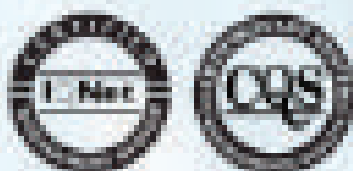
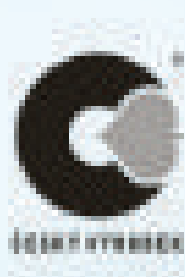

Certificates of our production plant.

REV1_2022